

2

Wiring Diagram for Workhorse, WHAM and Longhorse

Compact

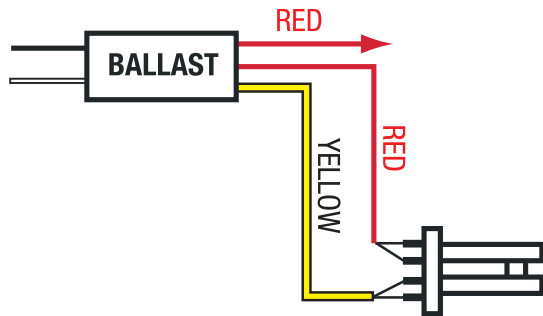

Linear

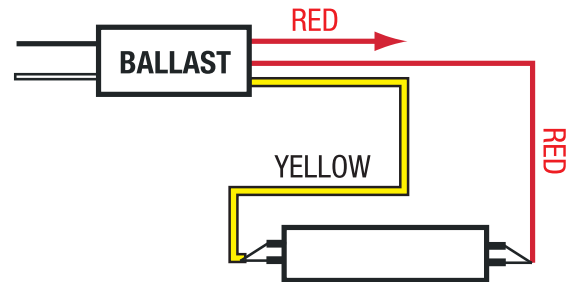

1. Connect both pin sets of the socket before connecting "RED" & "YELLOW" wires.
2. Ground case in accordance with the "National Electric Code."
3. With Linear lamps, use a starting aid.
4. Ballast case temperature can not exceed 70°C.
5. Remote mounting distance varies with lamp type. Contact customer service.
6. Ballast can not be used with dimmer switch but can be used with Occupancy Sensor.
(Note: Sensor will shorten lamp life.)
7. Cap and insulate any unused red power wire.
8. When connecting two red power wires, they must be joined to make one wire before attaching to the socket.
9. BLS (Back Leads with Studs) Dimensions: Stud Length: 5/8", Stud Size: 8/32, Center to Center: 2"
10. Running lamps in series will reduce the turn-on cycles of both lamps.
(Configuration diagrams 4, 5, 6)

Customer Service:

800.2.FULHAM or 323.779.2980

FAX: 323.754.9060

Fulham Co., Inc.,

12705 Van Ness Avenue

Hawthorne, CA 90250

www.fulham.com

WIRING JUMPER DETAIL

