

TMU24V008XLXXXA

Constant Voltage LED Linear Module

- High Density, high brightness chip array for use in Class 2 Linear applications
- Constant voltage for scalability
- Zhaga compliant to size and hole pattern
- On-board connector for ease of assembly
- Available in standard CCT's
- Dimmable when used with a dimmable driver
- Suitable for DLC and Energy Star compliance luminaires
- Optional lens to diffuse light
- 80 CRI standard and 90 CRI available

General Ratings

Max Lumen Output @ Input Voltage	845 lumens @ 4000K / 80 CRI*
Input Voltage	24V DC \pm 5%
Nominal DC Power Consumption	7.2W
Beam Angle	120°
CRI	80, 90
Operating Ambient Temperature Range (Ta)	-35 to +40°C
Maximum Module Case Temperature (Tc)	+90°C
Estimated Lumen Maintenance (L70)	>50,000 hours at max Tc
Color Consistency	Binning per ANSI C78.377-2008; 7 SDCM
Overall Size	11" x 1.4" x 0.24" (including connector)
Material / Weight	Aluminum Clad: 46 g ; FR4: 40 g
Maximum Screw Installation Torque	Aluminum Clad: 60 inch - ounces; FR4: 35 inch - ounces
Safety/Compliance	cURus (File # E351548) Class 2 Lighting System RoHS Compliant Zhaga Interface Specification Book 7, Edition 1.1, June 2013
Warranty	5 years with suitable Fulham LED Drivers

* At Tc mod = 25°C

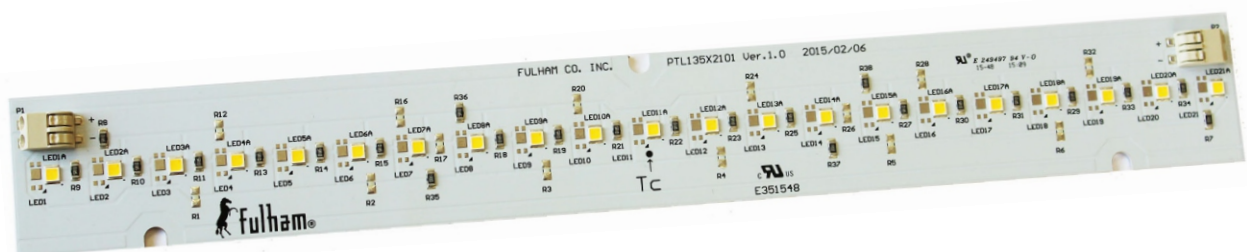

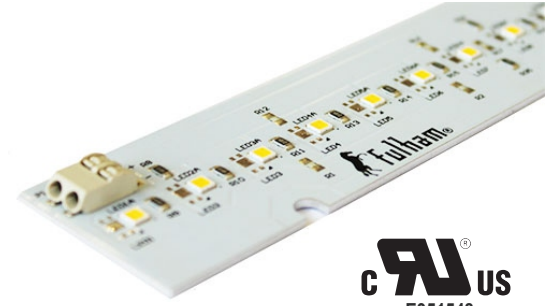

TMU24V008XLXXA

Part Numbering Matrix

T M U 24V 008 X L X XX A

Board Material & Options	CRI	Color Temperature
A = MCPCB + 18AWG Wire	8* = 80	27 = 2700K
B* = MCPCB +Connector	9 = 90	30* = 3000K
D = FR4 +18AWG Wire		35 = 3500K
E* = FR4 +Connector		40* = 4000K
		50 = 5000K

*Indicates standard module options. All others are built to order

Electrical Specifications

LED Module Part Number	Number of LED	Input Voltage	Nom. Rated Power
TMU24V008XLXXA	21	24V DC	7.2W

Electrical and Optical Specifications

LED Module Part Number	Color Temperature	Nominal Luminous Flux @ 90CRI	Nominal Luminous Flux @ 80CRI	Efficacy @80CRI
TMU24V008XLX30A	3000K	635 lumens	775 lumens	107 lm/W
TMU24V008XLX40A	4000K	690 lumens	845 lumens	117 lm/W

- 1) Electrical and optical specifications are based on Tc mod = 25°C. Reference Amb. Temp. vs Rel. Lum. Flux for other temperatures.
- 2) Standard lumen output and efficacy is calculated for standard options. Reference CCT vs Rel. Lum. Flux chart for lumen ratio calculation.
- 3) Specifications are subject to change without notice.

Thermal Specifications

	LED Module
Storage Temperature Range	-35 to 100°C
Operating Ambient Temperature Range	-35 to 40°C
Maximum Case Temperature (Tc mod)	90°C

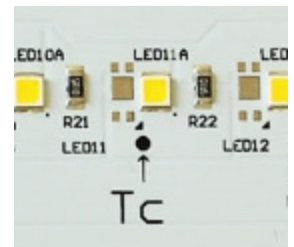

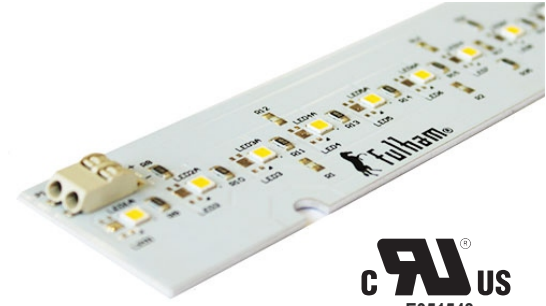

TMU24V008XLXXXA

Mechanical Drawings

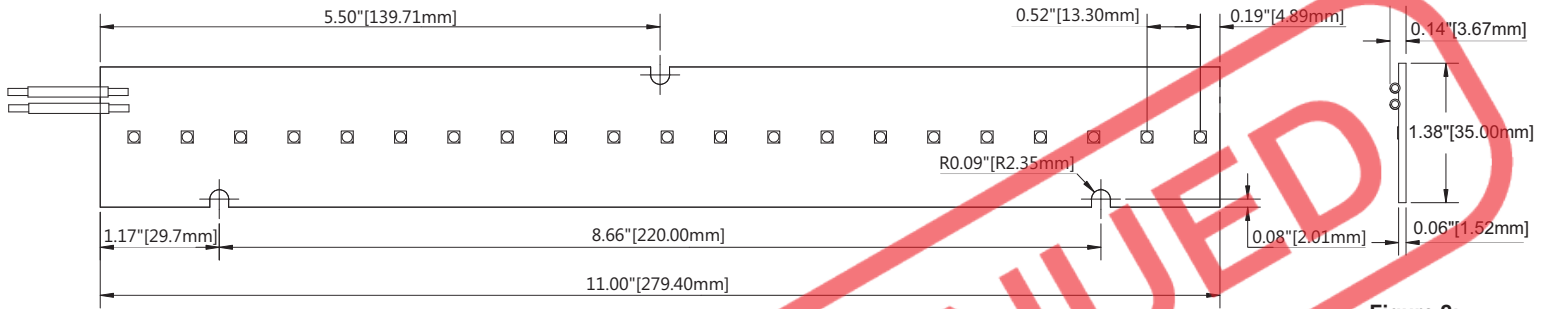

Figure 1: TMU24V008XLXXXA Top View with Wires

Figure 2:
TMU24V008XLXXXA
Side View with Wires



Figure 3: TMU24V008XLXXXA Top View with Connectors

Figure 4:
TMU24V008XLXXXA
Side View with
Connectors

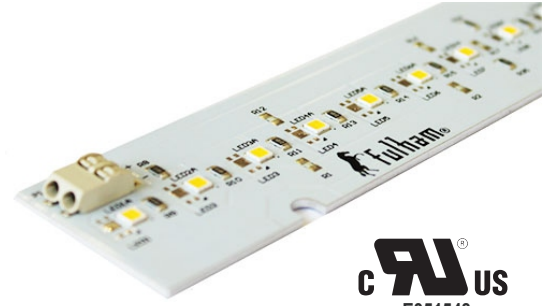

TMU24V008XLXXXA

Accessories

Interconnects

Wago Part Number: Single Pin **2060-901**; Double Pin **2060-902**

- Metal pin(s) to interconnect TMU24V008XLXXXA LED Modules
- Single pin connector for TMU24V008XLXXXA LED Modules in Series
- Double pin connector for TMU24V008XLXXXA LED Modules in Parallel
- For more detailed information, please visit Wago's website: <http://www.wago.com/infomaterial/pdf/51284479.pdf>

Single Pin



Double Pin



11" Diffuser Lens

Fulham Part Number: **TLE-OPT-120-002**

- 11" white polycarbonate diffuser lens
- Use same mounting holes as TMU24V008XLXXXA LED Module

TMU24V008XLXXXA + Diffuser Lens



Diffuser Lens

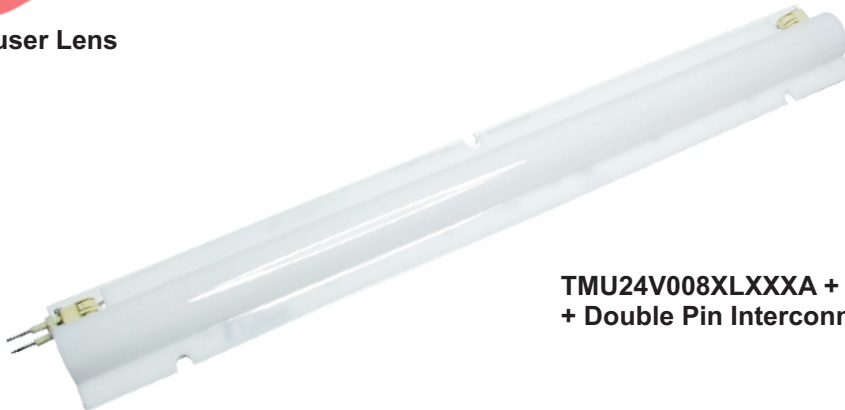

TMU24V008XLXXXA + Diffuser Lens
+ Double Pin Interconnect

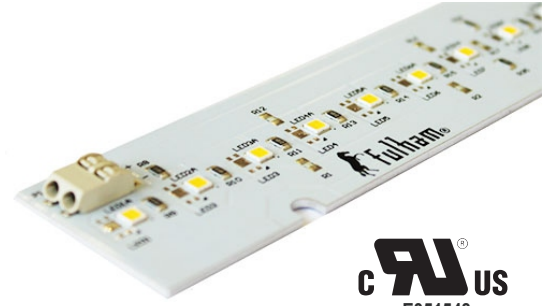

TMU24V008XLXXA

Termination Notes

- If connectors are used, use solid wire size 24 – 18 AWG, rated at a minimum 50V, minimum 105°C, and stripped to length between 6-7 mm (0.24-0.28 inches).
- Push button for insertion of conductor and for easy removal of wires.

Push Button

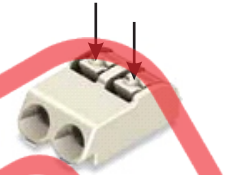

Fastening Notes

- If fastening by screw hole, use any screw with diameter less than 0.185 in (4.7mm). Use all available screw holes to ensure good contact between back side of module and mounting surface. Refer to max specified torque for installation. Suggested screw sizes: #6 or M4 Pan Head screw.
- If fastening using double-sided tape, start with clean, dust-free surface. Peel backing and place LED module on mounting surface. Firmly press down on the module to ensure good adherence. Follow the double-side tape manufacturer's installation instructions.

Environmental Rating

- Modules are rated for dry locations, unless option for conformal coating is requested.
- Conformal coating is acrylic based and rated for Environment and Moisture Protection per IPC-CC-830.

Electrostatic Sensitive Product (ESD)

- Fulham LED products should be handled with proper measures to protect against any potential ESD damage.
- When servicing, personnel should be ground and direct contact with LED should be avoided.

Thermal Management

- Proper thermal management should be employed to ensure life and reliability of product.
- Use of thermal grease, paste, pad, or other material interface is highly recommended.

Polarity Notes

- Modules are polarity sensitive.
- Ensure that “positive” from LED Driver is connected to “positive” of LED modules and that “negative” from LED Driver is connected to “negative” of LED modules.
- Polarities of modules are marked with “+” for positive and “-” for negative.

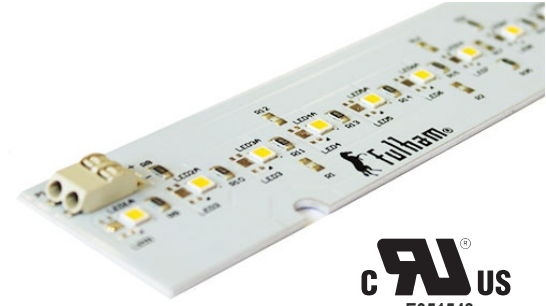

TMU24V008XLXXA

Color and Binning

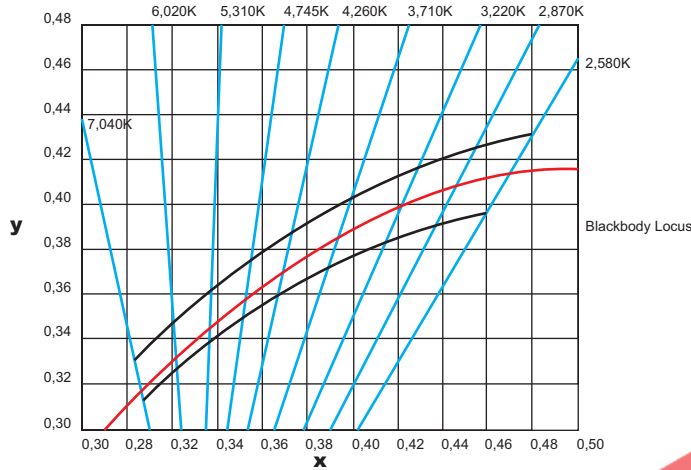

Ref. Nichia
Chromaticity Diagram for ANSI bins
For reference only. For more detailed info, contact factory.

Optical Spectrum***

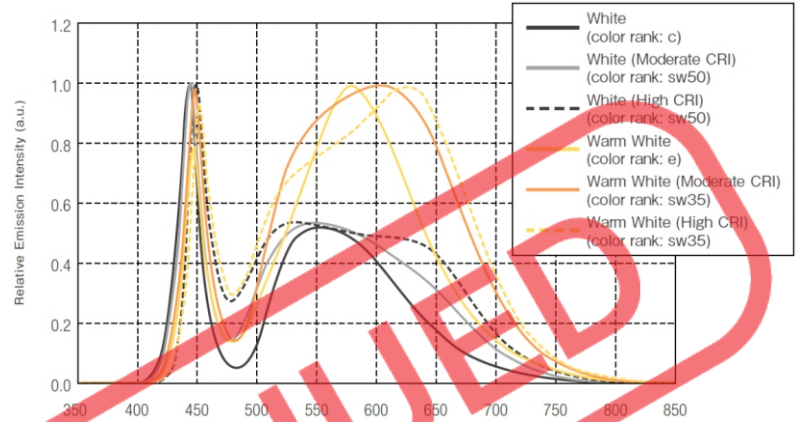

*** Value varies depending on product type and color rank
Ref. Nichia
LED Catalogue 2013
For reference only. For more detailed info, contact factory.

Thermal De-Rating

Ambient Temperature (Ta)	Thermal De-rating Multiplier
25°C	1
30°C	0.991
35°C	0.989
40°C	0.980
45°C	0.975
50°C	0.970
55°C	0.960
60°C	0.950

Ref. Nichia
LED757 Spec Sheet
For reference only. For more detailed info, contact factory.

CCT vs Luminous Flux

CCT	Luminous Flux Ratio
2700K	0.87
3000K	0.93
3500K	0.96
4000K	1.00
5000K	1.07

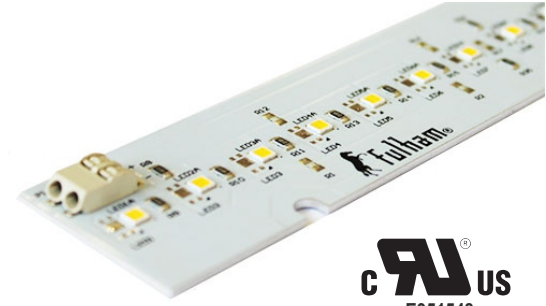

TMU24V008XLXXA

Compatible Fulham LED Drivers

Fulham Part Number	Driver Description	# of Modules/Driver	Wiring Diagram
T1UNV024V-20L	24V, 20W CV Driver, Universal Input	1, 2	A, C
T1M1UNV024V-20L	24V, 20W CV Driver, Universal Input, 0-10V Dimmable	1, 2	A, C
T1UNV024V-60L	24V, 60W CV Driver, Universal Input	1 ~ 7	A, C
T1M1UNV024V-60L	24V, 60W CV Driver, Universal Input, 0-10V Dimmable	1 ~ 7	A, C
T1UNV024V-75L	24V, 75W CV Driver, Universal Input	1 ~ 9	A, C
T1M1UNV024V-75L	24V, 75W CV Driver, Universal Input, 0-10V Dimmable	1 ~ 9	A, C
T1UNV024V-150L	24V, 150W CV Driver, Universal Input	1 ~ 18	A, C
T1M1UNV024V-150L	24V, 150W CV Driver, Universal Input, 0-10V Dimmable	1 ~ 18	A, C
T1UNV024V-100LE	24V, 100W CV Driver, Universal Input	1 ~ 12	A, C
T1UNV024V-100LS	24V, 100W CV Driver, Universal Input	1 ~ 12	A, C

NOTE:

1. Subject to rated loading conditions.
2. Modules are polarity sensitive. Ensure that "positive" from LED Driver is connected to "positive" of LED modules and that "negative" from LED Driver is connected to "negative" of LED modules.
3. List is subject to change without notice.

Wiring Diagram

