

SPECIFICATION SHEET : RHA-347-226-BLS

This Is An Original Product From Fulham Co., Inc

Description : RACEHORSE Series, Operating Voltage 347V, Programmed Start Ballast, End Of Life Protection, Auto Restart, Cold Starting Feature.

This Ballast Will Operate Following Lamps.

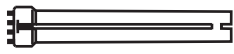

TWIN (CFT), 4 PIN
13/18/24/36W



QUAD (CFQ), 4 PIN
26W



TRIPLE (CFTR)
26/32/42W



2D21/28/38W



CFM57W



CIRCLINE
T5CR22/40W



F24T5HO

ELECTRICAL DATA (With 347 Volt Application)

INPUT VOLT: 347V ± 10%, 50/60Hz									
LAMP WATTS/TYPE	CFQ26W	CFTR26W	CFTR32W	CFTR42W	FT13W	FT18W	FT24W	FT36W	2D21W
LAMPS OPERATED	1								
INPUT WATTS	29	28	30	50	15	19	27	34	25
LINE CURRENT:	0.08	0.08	0.09	0.15	0.05	0.06	0.08	0.10	0.08
POWER FACTOR	0.98	0.98	0.98	0.99	0.94	0.96	0.98	0.98	0.97
BALLAST FACTOR	1.05	1.05	0.98	0.97	1.25	1.00	1.05	0.87	1.43
EFFICACY FACTOR	3.67	3.71	3.24	1.94	8.10	5.25	3.91	2.55	5.62
THD	< 10%								
CURRENT CREST FACTOR	< 1.7								
EMI/RFI COMPLIANCE	FCC PART 18-A (NON-CONSUMER)								
SOUND RATING	"A"								
BALLAST TYPE	PROGRAMMED START								
VOLTAGE TRANSIENTS	MOV (ANSI C82.11)								
INPUT/PROTECTION	FUSE								
OUTPUT/PROTECTION	OPEN LAMP, SHORTED LAMP, END-OF-LIFE								
MIN. OPERATING TEMP	-30°C (-22°F)								
MAX. CASE TEMP	90°C (194°F) SEE FOOT NOTE WARRANTY								
APPROVALS/CLASS	UL /cUL LISTED, CLASS " P ", 1 OUTDOOR								
REMOTE MOUNTING	18 FT MAX.								

MECHANICAL DATA

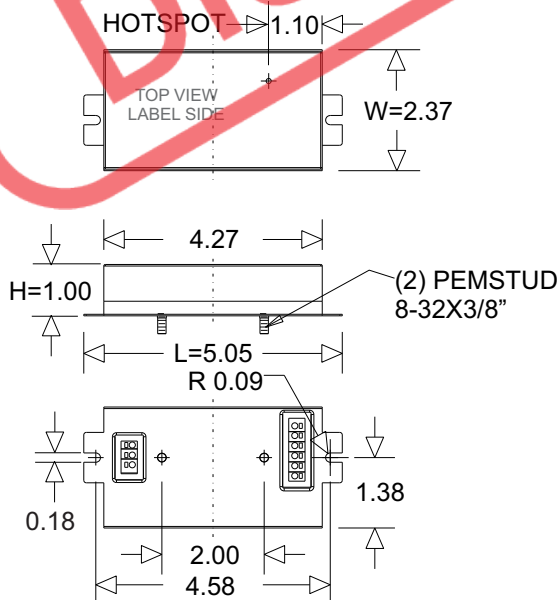

WIRING DIAGRAMS

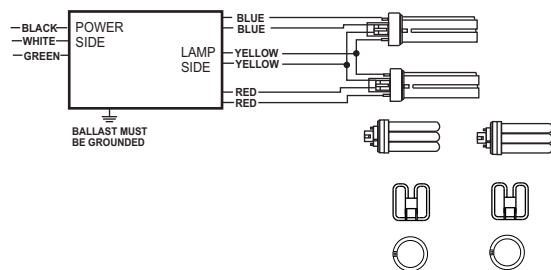
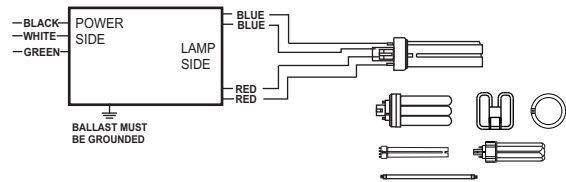

Use Wire Rated 300V, 90°C min. Use 18 AWG Solid Copper Wire Only Stripped to 3/8"

NOTE : This Ballast Must Be Grounded

SPECIFICATION SHEET : RHA-347-226-BLS

This Is An Original Product From Fulham Co., Inc

Description : RACEHORSE Series, Operating Voltage 347V, Programmed Start Ballast, End Of Life Protection, Auto Restart, Cold Starting Feature.

This Ballast Will Operate Following Lamps.



TWIN(CFT), 4 PIN
13/18/24/36W



QUAD (CFQ), 4 PIN
26W

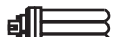

TRIPLE(CFTR)
26/32/42W



2D21/28/38W



CFM57W



CIRCLINE
T5CR22/40W



F24T5HO

ELECTRICAL DATA (With 347 Volt Application)

INPUT VOLT: 347V ± 10%, 50/60Hz										
LAMP WATTS/TYPE	2D28W	2D38W	T5CR22W	T5CR40W	CFM57W	CFQ26W	CFTR26W	FT18W	FT24W	
LAMPS OPERATED	1					2				
INPUT WATTS	33	34	28	39	51	57	57	34	50	
LINE CURRENT:	0.10	0.10	0.08	0.11	0.15	0.17	0.17	0.10	0.14	
POWER FACTOR	0.98	0.98	0.98	0.98	0.99	0.99	0.99	0.98	0.99	
BALLAST FACTOR	1.25	0.88	1.05	0.98	0.96	0.98	0.98	0.95	0.98	
EFFICACY FACTOR	3.80	2.60	3.77	2.50	1.89	1.72	1.74	2.77	1.98	
THD	< 10%									
CURRENT CREST FACTOR	< 1.7									
EMI/RFI COMPLIANCE	FCC PART 18-A (NON-CONSUMER)									
SOUND RATING	"A"									
BALLAST TYPE	PROGRAMMED START									
VOLTAGE TRANSIENTS	MOV (ANSI C82.11)									
INPUT/PROTECTION	FUSE									
OUTPUT/PROTECTION	OPEN LAMP, SHORTED LAMP, END-OF-LIFE									
MIN. OPERATING TEMP	-30°C (-22°F)									
MAX. CASE TEMP	90°C (194°F) SEE FOOT NOTE WARRANTY									
APPROVALS/CLASS	UL /cUL LISTED, CLASS " P ", 1 OUTDOOR									
REMOTE MOUNTING	18 FT MAX.									

MECHANICAL DATA

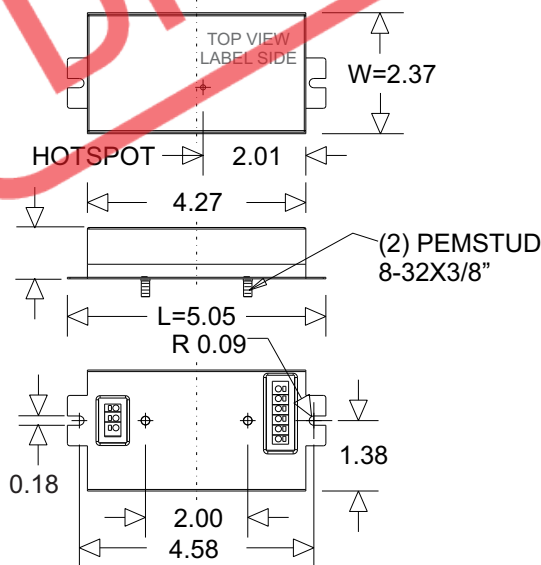

Where : L = Length, W = Width, H = Height

WIRING DIAGRAMS

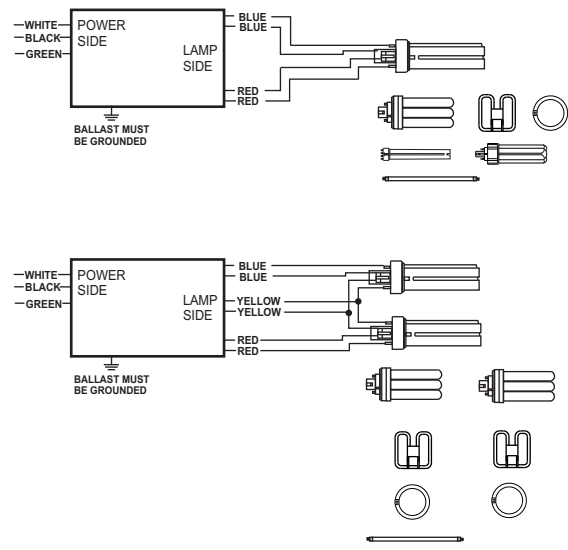

Use Wire Rated 300V, 90°C min. Use 18 AWG Solid Copper Wire Only Stripped to 3/8"

NOTE : This Ballast Must Be Grounded

Fulham extends a limited warranty only to the original purchaser or to the first user for a period of 5 years @ 75°C or 3 years @ 90°C from the date of manufacture when properly installed and operated under normal conditions of use. For complete terms and conditions, please reference the Fulham product catalog (www.fulham.com) Due to a program of continuous improvement, Fulham reserves the right to make modifications or variations in design or construction to the equipment described. © Fulham Company Limited, All Rights Reserved.

SPECIFICATION SHEET : RHA-347-226-BLS

This Is An Original Product From Fulham Co., Inc

Description : RACEHORSE Series, Operating Voltage 347V, Programmed Start Ballast, End Of Life Protection, Auto Restart, Cold Starting Feature.

This Ballast Will Operate Following Lamps.



TWIN (CFT), 4 PIN
13/18/24/36W



QUAD (CFQ), 4 PIN
26W

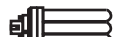

TRIPLE (CFTR)
26/32/42W



2D21/28/38W



CFM57W



CIRCLINE
T5CR22/40W



F24T5HO

ELECTRICAL DATA (With 347 Volt Application)

INPUT VOLT: 347V ± 10%, 50/60Hz

LAMP WATTS/TYPE	FT13W	2D21W	F24T5HO						
LAMPS OPERATED	2								
INPUT WATTS	31	54	53						
LINE CURRENT:	0.09	0.16	0.15						
POWER FACTOR	0.98	0.99	0.99						
BALLAST FACTOR	1.20	1.32	0.97						
EFFICACY FACTOR	3.93	2.46	1.84						
THD	< 10%								
CURRENT CREST FACTOR	< 1.7								
EMI/RFI COMPLIANCE	FCC PART 18-A (NON-CONSUMER)								
SOUND RATING	"A"								
BALLAST TYPE	PROGRAMMED START								
VOLTAGE TRANSIENTS	MOV (ANSI C82.11)								
INPUT/PROTECTION	FUSE								
OUTPUT/PROTECTION	OPEN LAMP, SHORTED LAMP, END-OF-LIFE								
MIN. OPERATING TEMP	-30°C (-22°F)								
MAX. CASE TEMP	90°C (194°F) SEE FOOT NOTE WARRANTY								
APPROVALS/CLASS	UL /cUL LISTED, CLASS " P ", 1 OUTDOOR								
REMOTE MOUNTING	18 FT MAX.								

MECHANICAL DATA

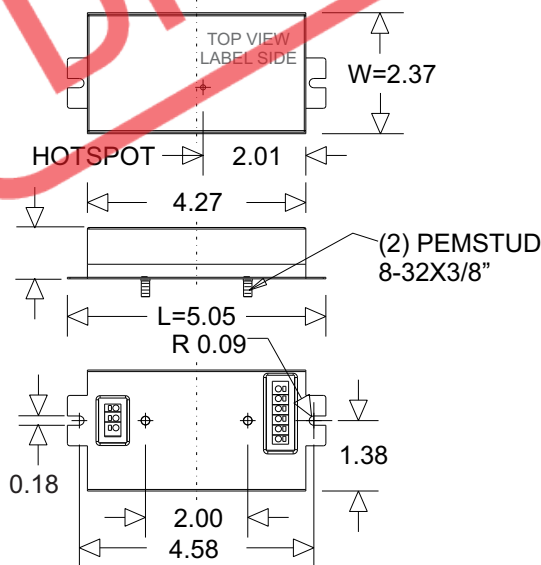

Where : L = Length, W = Width, H = Height

WIRING DIAGRAMS

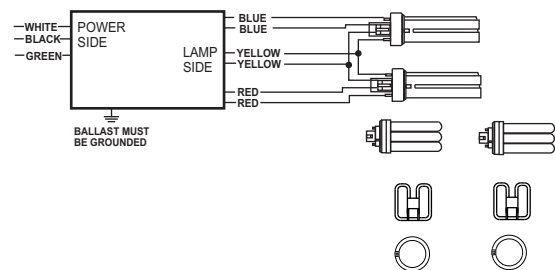
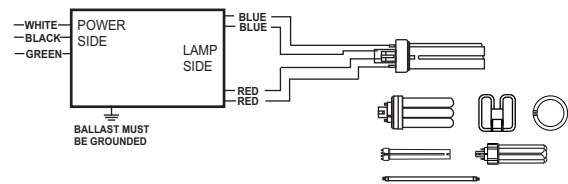

Use Wire Rated 300V, 90°C min. Use 18 AWG Solid Copper Wire Only Stripped to 3/8"

NOTE : This Ballast Must Be Grounded

Fulham extends a limited warranty only to the original purchaser or to the first user for a period of 5 years @ 75°C or 3 years @ 90°C from the date of manufacture when properly installed and operated under normal conditions of use. For complete terms and conditions, please reference the Fulham product catalog (www.fulham.com) Due to a program of continuous improvement, Fulham reserves the right to make modifications or variations in design or construction to the equipment described. © Fulham Company Limited, All Rights Reserved.