



INSTALLATION SHEET : RH1-UNV-213-K

This Is An Original Product From Fulham Co., Inc

Description : This Kit Contains Universal Voltage CFL Electronic Ballast, Which Consist Of Advance Features like Program Start, End Of Life Protection, Flicker Free Operation, Auto-restart The Kit Includes Ballast, Snap-on-plate, Required Wires, Nuts, Wire Removing Tool, Screw.

Application : Numerous Application Such As Retrofit Down Light.

Safety, Warning and Suggestions

(1) Qualified electrician is required to install this product/s. (2) To prevent electrical shock and injury, be sure to disconnect power prior to mounting of this fixture/s. (3) All wiring and installations should meet local, state and national electrical codes. (4) Install correct lamp type and wattage.

This Ballast Will Operate Following Lamps.

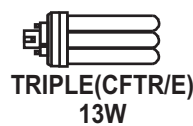
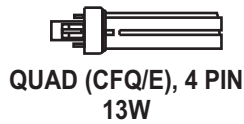
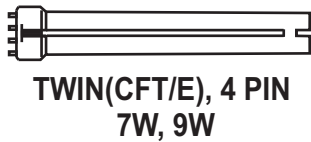

List Of Item Enclosed

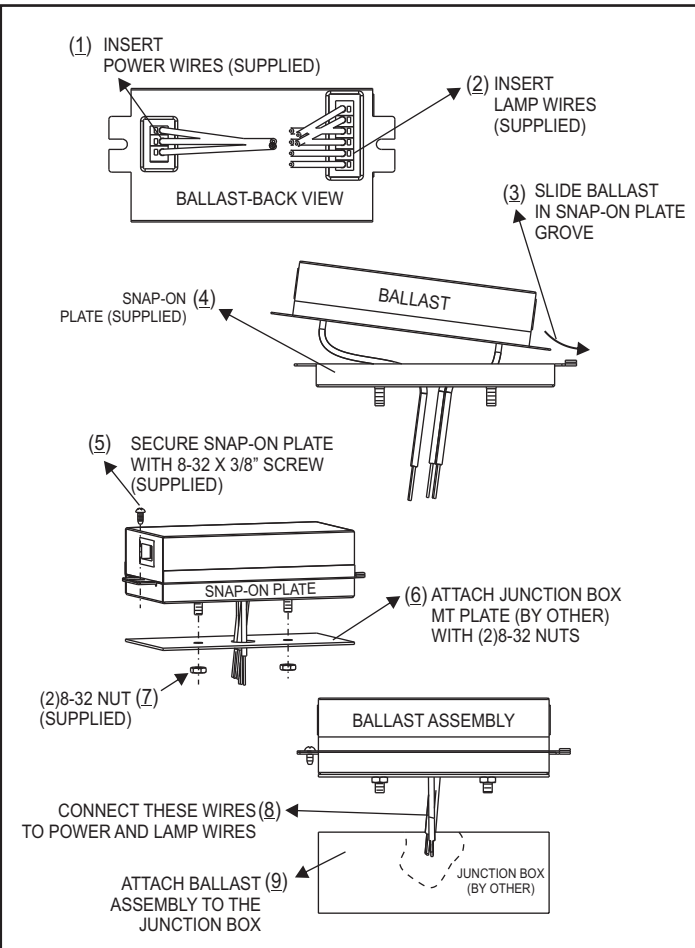
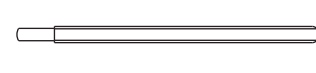
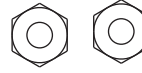
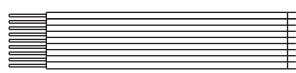

Las Instrucciones En Español.

- 1) insertar los alambres de la energía (proveída).
- 2) insertar los alambres de la lámpara (proveída).
- 3) resbalar el lastre en arboleda.
- 4) placa snap-on (proveída)
- 5) asegurar la placa snap-on con 8-32 x 3/8 " tornillo (proveída).
- 6) unir la placa MT con la caja de ensambladura con (2) 8-32 tuercas
- 7) (2) tuerca 8-32 (proveída).
- 8) Conecte Estos Alambres Con La Energía y Los Alambres De La Lámpara.
- 9) unir el montaje del lastre a la caja de ensambladura.

L'instruction d'installation en français

- 1) INSÉREZ LES FILS CONDUCTEUR (FOURNIS)
- 2) INSÉREZ LES FILS DE LAMPES (FOURNIS)
- 3) GLISSEZ LE BALLAST DANS LA FENTE DE LA PLQUE "SNAO-ON"
- 4) PLAQUE "SNAP-ON" (FOURNIS)
- 5) VISSEZ LA PLAQUE "SNAP-ON" AVEC DES VIS 8.32X3/8" (FOURNIS)
- 6) INSTALLEZ LA BOITE DE JONCTION A LA PLAQUE DE MONAGE AVEC DES ÉCROUS (2)8-32
- 7) (2) ÉCROUS 8-32 (FOURNIS)
- 8) RACCORDEZ CES FILS AUX FILS CONDUCTEUR ET AUX FILS DE LAMPES
- 9) UNISSEZ LE BALLAST À LA BOITE DE JONCTION

Fulham Co., Inc extends limited warranty only to the original purchaser or to the first user for the period of 3 years @ 90° C & 5 years @ 70° C from the date of manufacture as indicated by the date code stamped on each product and when properly installed and under normal conditions of use. For additional warranty guide line, please refer to our Complete Product Catalog OR call Customer Service at 1-323-599-5001.

DUE TO A PROGRAM OF CONTINUOUS IMPROVEMENT, FULHAM Co., INC RESERVES THE RIGHT TO MAKE ANY VARIATION IN DESIGN OR CONSTRUCTION TO THE EQUIPMENT DESCRIBED.

Address : 12705 South Van Ness Ave., Hawthorne, CA 90250 Tel.: 1-323-599-5001, Fax.: 1-323-754-9060. Website: www.fulham.com

2006-90 rev A