



- Constant Current LED Driver
- Output Wattage: 40W
- Input Voltage: 240±15%, 50Hz
- Output Current: 700mA±8%
- Wired; PC Enclosure
- Output voltage range of 40-57VDC
- Dry, Damp and Wet Locations
- 440Vac Protection
- Under Voltage Protection
- Over Voltage Protection

General Specifications

Rated Input Voltage	240VAC ±15%, 50Hz
Operating Input Voltage Range	110VAC~320VAC, 50Hz
Input Current	0.4 A Max.
Input Power	49W Max.
Power Factor	>0.95
THD	<10% across load range specified
Efficiency	>86% across load range specified
Driver Type	Constant Current
Output Current	700mA ±8%
Output Voltage Range	40-57VDC
Output Power	40W
No Load Output Voltage	>65V
Number of Output Channels	1 Channel
Dimming Controller Type/Dimming Range	NA
RFI/EMI	NA
Output Type	Class II (IEC 61140)
Ambient Operating Temperature Range	-10°C to 50°C
Max. Case Temperature	80°C
Sound Rating	NA
Input Surge Protection	Line-Neutral 4kV DM
Protections	Input Over Current : NON-Resettable
	Input Over Voltage : CUTOFF @ Vin>325Vac; AUTORECOVERY @ Vin = 300-315Vac : Immunity - 320Vac for 48 hours & 440Vac for 8 hours
	Input Under Voltage : CUTOFF @ Vin <100Vac; AUTORECOVERY @ Vin = 100-110Vac
	Output Short Circuit : Auto recovery
	Output Open Circuit : Auto recovery
	Output to ground short : YES
	Output Overload : YES
	Over Temperature : NA
Service Life	50,000 hours @ Tc Max
Approvals / Class	Dry, Damp and Wet Locations
Warranty	3 years
Weight	0.320Kg

Note : The usage of a compatible* SPD is mandatory for outdoor application.

*Compatibility : Any SPD with Up (L-N) ≤ 1700V (Up- Voltage protection level as defined in IEC61643-11)

Recommended Fulham SPD - SPD1360S5A5K67



Figure 1

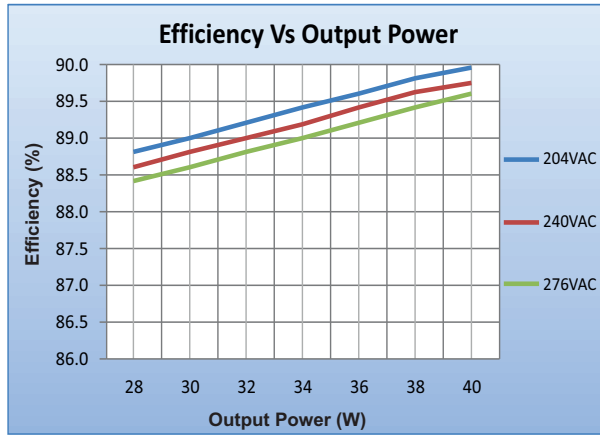

Figure 2

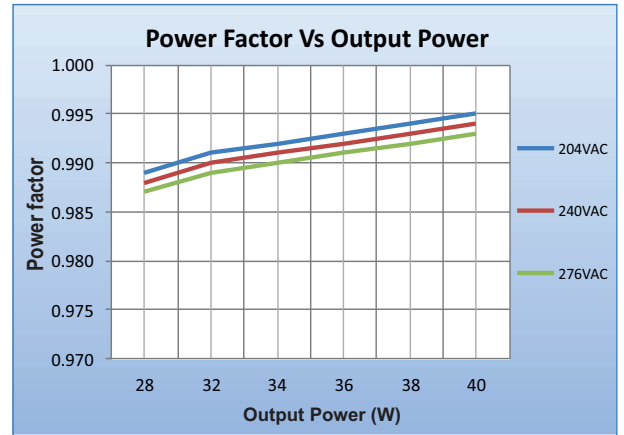

Figure 3

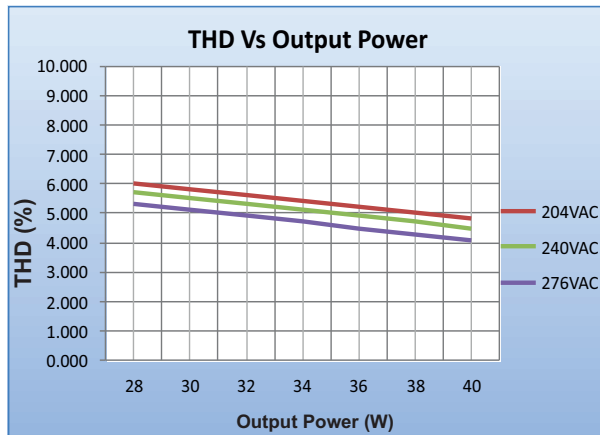

Figure 4

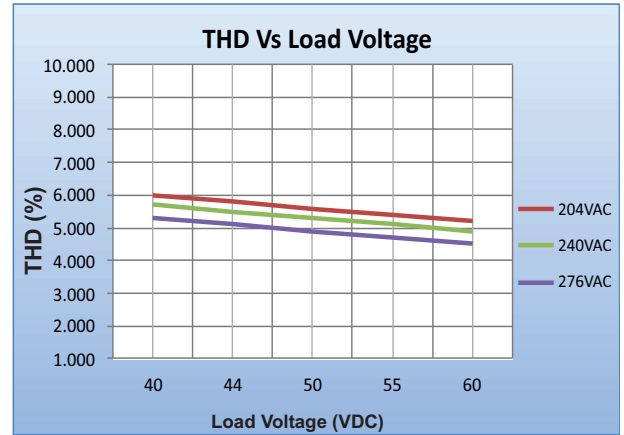

Figure 5

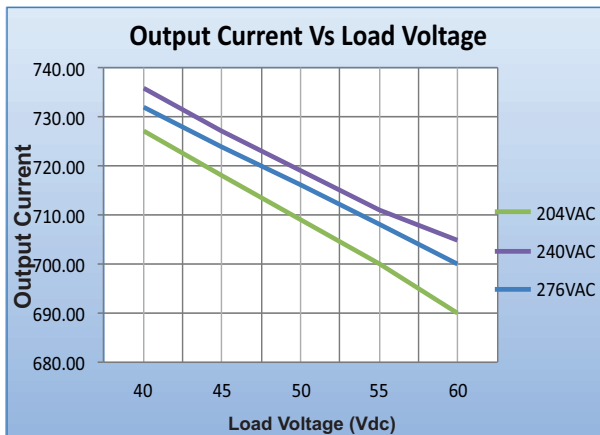
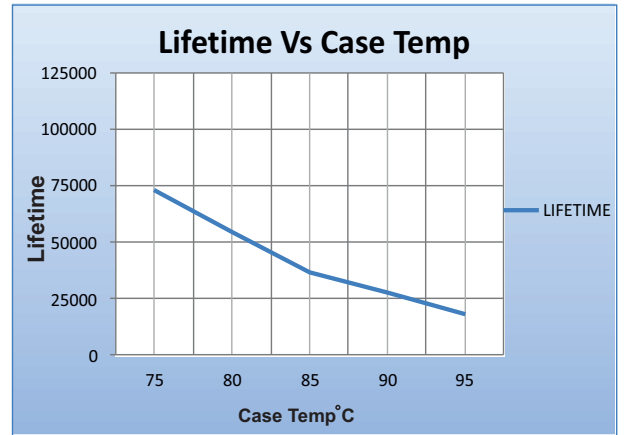

Figure 6



Fulham extends a limited warranty only to the original purchaser or to the first user for a period of 3 years @ Tc 80°C from the date of manufacture when properly installed and operated under normal conditions of use. For complete terms and conditions, please reference the Fulham Product Catalog (www.fulham.com). Due to a program of continuous improvement, Fulham reserves the right to make modifications or variations in design or construction to the equipment described. © Fulham Company Limited, All Rights Reserved.



Mechanical Data

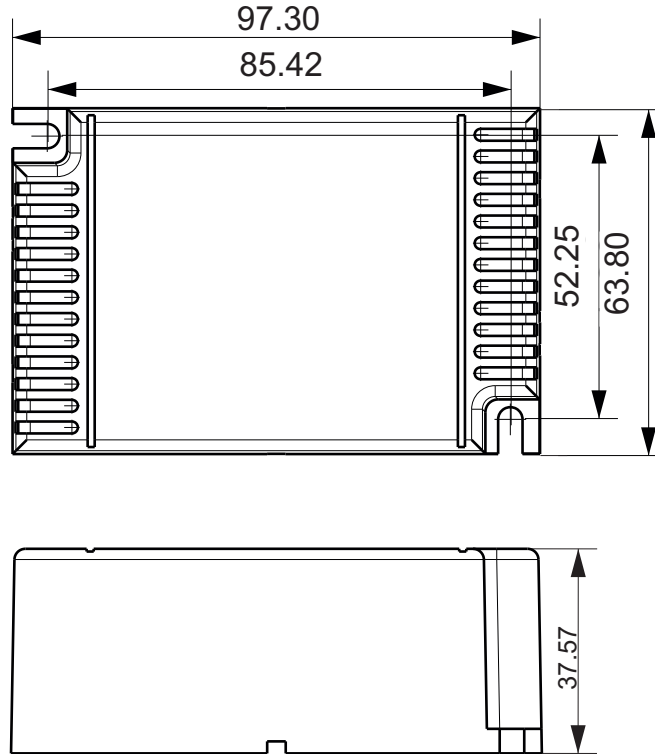

Note : All Dimensions are in mm.

Tolerance=±0.5mm

Wiring Diagrams

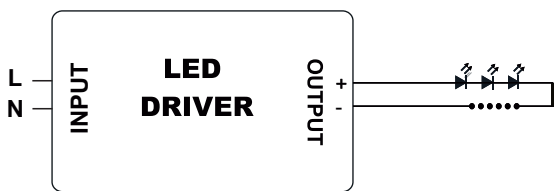

INPUT SIDE	LENGTH
BLACK	250 mm
WHITE	250 mm

OUTPUT SIDE	LENGTH
RED	250 mm
BLUE	250 mm

Output wire with Terminal: N. A.

Installation Instructions:

Connect Wires as per details given on the Driver Screen. Keep proper ventilation around the LED Driver and do not stack any object on it. Also a 10-15 cm clearance must be kept when the adjacent device is a heat source. Do not exceed the declared Hot spot temperature(Tc max) under any circumstances.