

Description: 25W Constant Current LED Driver, Single Channel, 24-50V, 0.5A (Non Dimmable)

This Driver Will Operate The Following LED Modules:

Any LED module designed to accept 500mA and a voltage of 24-50VDC.

ELECTRICAL DATA

RATED INPUT VOLTAGE	240 VAC, 50Hz
OPERATING INPUT VOLTAGE RANGE	70 VAC~277 VAC, 50Hz
OPTIMUM PERFORMANCE INPUT VOLTAGE RANGE	150 VAC~277VAC, 50Hz
INPUT CURRENT	0.13A MAX
POWER FACTOR	0.97
ATHD	10%
EFFICIENCY	>86%
INPUT POWER	30W MAX
OUTPUT TYPE	CONSTANT CURRENT
OUTPUT CURRENT	500mA
OUTPUT VOLTAGE	24~50 VDC
OUTPUT POWER	25W
NUMBER OF OUTPUT CHANNELS	1
EMI	N.A
DIMMING CONTROLLER TYPE	N.A
DIMMING RANGE	N.A
MAX.CASE HOT SPOT TEMPERATURE (Tc MAX)	70°C
OPERATING TEMPERATURE	-25°C TO 50°C
APPROVALS CLASS (CONFORMING TO)	CLASS II, IP20
HOT PLUG - IN	YES
CASE MATERIAL	PLASTIC (PC)
WEIGHT	0.17 KG

CIRCUIT PROTECTION

SURGE PROTECTION	LINE-NEUTRAL 4kV DM
INPUT OVER CURRENT PROTECTION	NON-RESETTABLE
INPUT OVER VOLTAGE	APPLICATION @ 320VAC 48 HRS. & @ 360VAC 2 HRS..
INPUT UNDER VOLTAGE	N.A
OUTPUT SHORT CIRCUIT PROTECTION	AUTORECOVERY (HICCUP MODE)
OUTPUT OPEN CIRCUIT PROTECTION	AUTORECOVERY (HICCUP MODE)
OUTPUT TO GROUND SHORT PROTECTION	YES
OUTPUT OVERLOAD PROTECTION	YES
OVER TEMPERATURE PROTECTION	N.A

Note: All performance specified at Rated voltage and full load. Output current tolerance: ±5%

The usage of appropriate SURGE PROTECTIVE DEVICE (SPD) is MANDATORY for Outdoor drivers.

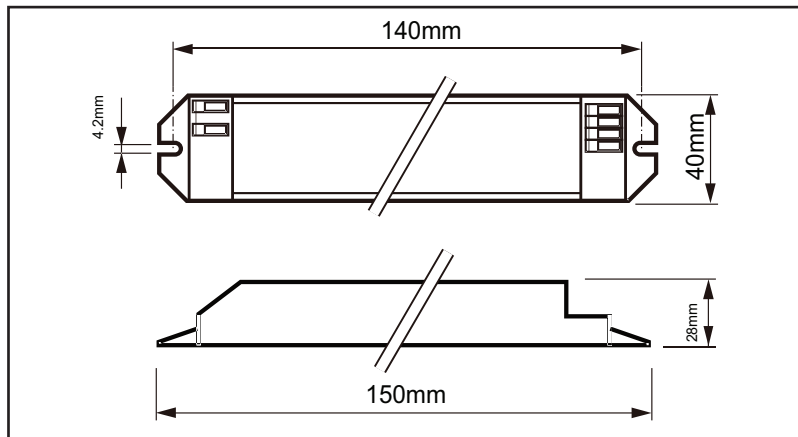
MECHANICAL DATA

WIRING DIAGRAMS

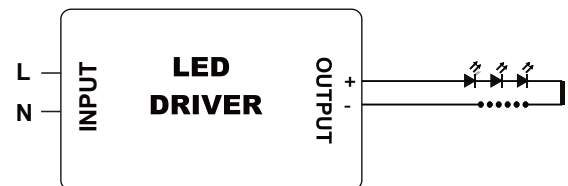
INPUT SIDE	LENGTH	OUTPUT SIDE	LENGTH
BLACK	N.A	RED	N.A
WHITE	N.A	BLUE	N.A
GREEN	N.A	Output wire with Terminal:	N.A

Installation Instructions: Keep proper ventilation around the LED Driver and do not stack any object on it. Also a 10-15 cm clearance must be kept when the adjacent device is a heat source. Do not exceed the declared Hot spot temperature(Tc max) under any circumstances.

 Fulham extends a limited warranty only to the original purchaser or to the first user for a period of 3 years from the date of manufacture when properly installed and operated under normal conditions of use. For complete terms and conditions, please reference the Fulham product catalog (www.fulham.com)
Due to a program of continuous improvement, Fulham reserves the right to make modifications or variations in design or construction to the equipment described. © Fulham Company Limited, All Rights Reserved.