



**Discontinued**  
Contact Fulham for availability. Not for use in new designs.

## SPECIFICATION SHEET : SHGS1-MID-2-200-L-10

This Is An Original Product From Fulham Co., Inc

**Description : Sun Horse electronic ballast developed for use with UV & tanning lamp applications**

**This Ballast Will Operate Following Lamps.**

  
**1 OR 2 X F59T12VHO, F60T12VHO,  
F71T12VHO, F72T12VHO, F73T12VHO,  
F74T12VHO, F79T12VHO**

### ELECTRICAL DATA (208V APPLICATION)

INPUT VOLT: 208V ± 10%, 50/60Hz , with 1.60 Amp application								
LAMP WATTS/TYPE	F59T12VHO	F60T12VHO	F71T12VHO	F72T12VHO	F73T12VHO	F74T12VHO	F79T12VHO	F79T12VHO
LAMP RATED POWER	140W	135W	160W	165W	160W	200W	180W	200W
LAMPS OPERATED	1							
INPUT WATTS	129	153	176	195	168	184	172	202
LINE CURRENT :	0.65	0.76	0.87	0.96	0.83	0.90	0.85	0.99
POWER FACTOR	0.95	0.96	0.97	0.98	0.97	0.97	0.97	0.98
BALLAST FACTOR	0.8	0.0	1.0	1.1	1.0	0.9	0.9	0.9
EFFICACY FACTOR	0.6	0.0	0.6	0.6	0.6	0.5	0.5	0.5
OPERATING FREQUENCY	56KHz							
THD	< 20%							
CURRENT CRESS FACTOR	< 1.7							
EMI/RFI COMPLIANCE	FCC PART 18-A							
SOUND RATING	" A "							
BALLAST TYPE	INSTANT START							
VOLTAGE TRANSIENTS	ANSI C82.11 - 1993 / C62.41							
INHERENT THERMAL PROT.	YES							
MIN. OPERATING TEMP	0 °C ( 32 °F )							
MAX. CASE TEMP	75 °C ( 167 °F )							
APPROVALS/CLASS	UL /cUL LISTED, CLASS " P " , 1 OUTDOOR							

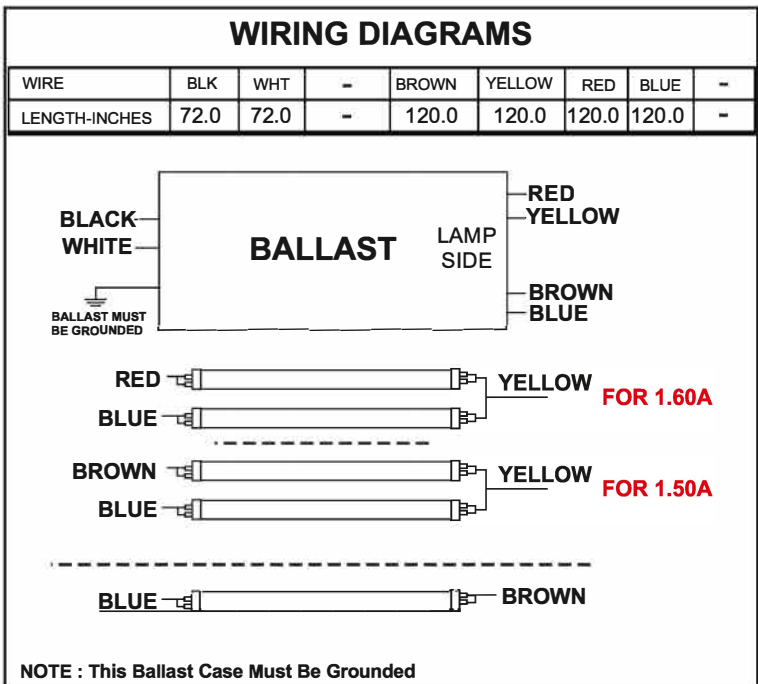
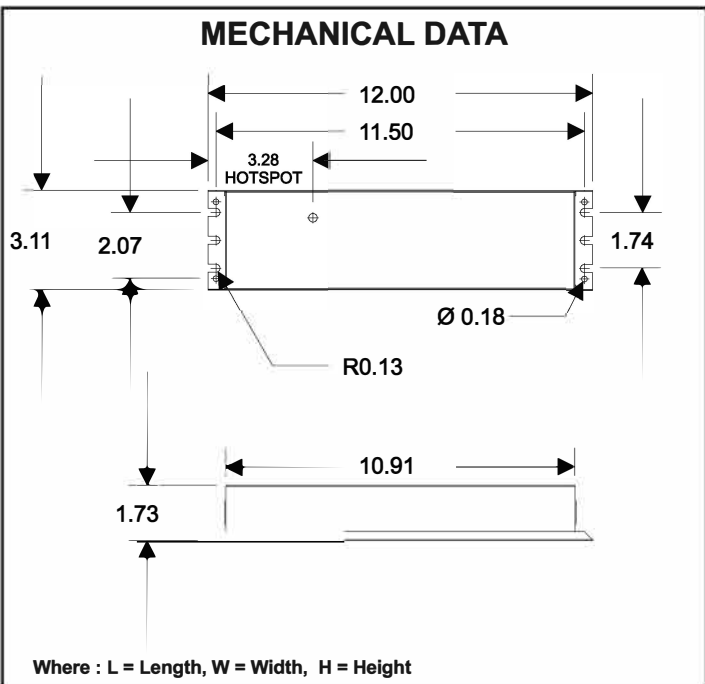

Fulham Co., Inc extends limited warranty only to the original purchaser or to the first user for the period of **3 years** from the date of manufacture as indicated by the date code stamped on each product and when properly installed and under normal conditions of use. For additional warranty guide line, please refer to our Complete Product Catalog OR call Customer Service at 1-323-599-5000.  
 DUE TO A PROGRAM OF CONTINUOUS IMPROVEMENT, FULHAM Co., INC RESERVES THE RIGHT TO MAKE ANY VARIATION IN DESIGN OR CONSTRUCTION TO THE EQUIPMENT DESCRIBED.  
 Address : 12705 South Van Ness Ave., Hawthorne, CA 90250 Tel.: 1-323-599-5000, Fax.: 1-323-754-9060. Website: www.fulham.com 2006-223-1 rev C



# SPECIFICATION SHEET : SHGS1-MID-2-200-L-10

This Is An Original Product From Fulham Co., Inc

**Description : Sun Horse electronic ballast developed for use with UV & tanning lamp applications**

**This Ballast Will Operate Following Lamps.**

  
**1 OR 2 X F59T12VHO, F60T12VHO, F71T12VHO, F72T12VHO, F73T12VHO, F74T12VHO, F79T12VHO**

## ELECTRICAL DATA (208V APPLICATION)

INPUT VOLT: 208V ± 10%, 50/60Hz, <span style="color: red;">with 1.60 Amp application</span>								
LAMP WATTS/TYPE	F59T12VHO	F60T12VHO	F71T12VHO	F72T12VHO	F73T12VHO	F74T12VHO	F79T12VHO	F79T12VHO
LAMP RATED POWER	140W	135W	160W	165W	160W	200W	180W	200W
LAMPS OPERATED	2							
INPUT WATTS	268	301	313	329	328	351	361	381
LINE CURRENT:	1.30	1.46	1.51	1.59	1.57	1.69	1.74	1.84
POWER FACTOR	0.99	0.99	0.99	0.99	0.99	0.99	0.99	0.99
BALLAST FACTOR	0.9	1.1	0.9	0.9	1.0	0.8	0.9	0.9
EFFICACY FACTOR	0.3	0.4	0.3	0.3	0.3	0.2	0.3	0.2
OPERATING FREQUENCY	56KHz							
THD	< 10%							
CURRENT CRESS FACTOR	< 1.7							
EMI/RFI COMPLIANCE	FCC PART 18-A							
SOUND RATING	" A "							
BALLAST TYPE	INSTANT START							
VOLTAGE TRANSIENTS	ANSI C82.11 - 1993 / C62.41							
INHERENT THERMAL PROT.	YES							
MIN. OPERATING TEMP	0 °C ( 32 ° F )							
MAX. CASE TEMP	75 °C ( 167 ° F )							
APPROVALS/CLASS	UL /cUL LISTED, CLASS " P ", 1 OUTDOOR							

### MECHANICAL DATA

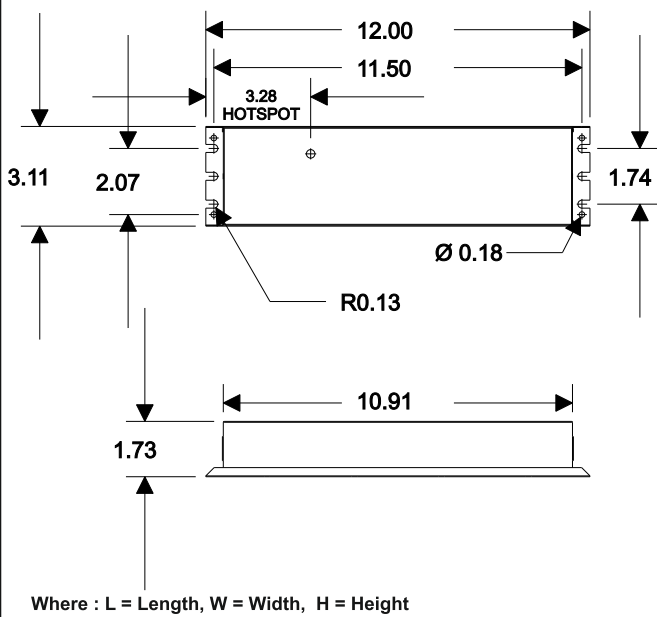

### WIRING DIAGRAMS

WIRE	BLK	WHT	-	BROWN	YELLOW	RED	BLUE	-
LENGTH-INCHES	72.0	72.0	-	120.0	120.0	120.0	120.0	-

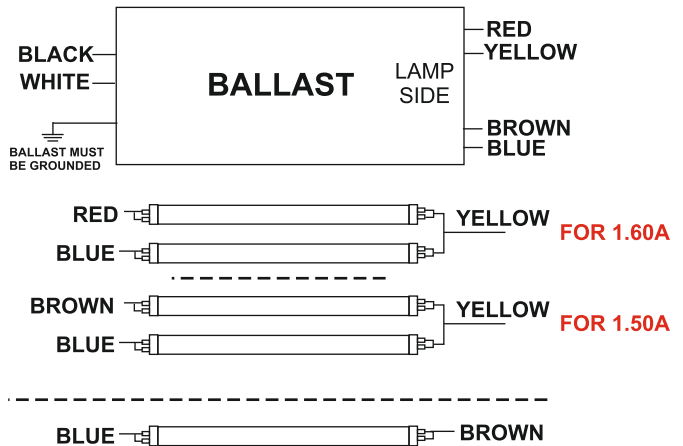

**NOTE : This Ballast Case Must Be Grounded**

Fulham Co., Inc extends limited warranty only to the original purchaser or to the first user for the period of **3 years** from the date of manufacture as indicated by the date code stamped on each product and when properly installed and under normal conditions of use. For additional warranty guide line, please refer to our Complete Product Catalog OR call Customer Service at 1-323-599-5000.

DUE TO A PROGRAM OF CONTINUOUS IMPROVEMENT, FULHAM Co., INC RESERVES THE RIGHT TO MAKE ANY VARIATION IN DESIGN OR CONSTRUCTION TO THE EQUIPMENT DESCRIBED.

Address : 12705 South Van Ness Ave., Hawthorne, CA 90250 Tel.: 1-323-599-5000, Fax.: 1-323-754-9060. Website: [www.fulham.com](http://www.fulham.com) 2006-223-2 rev C



## SPECIFICATION SHEET : SHGS1-MID-2-200-L-10

This Is An Original Product From Fulham Co., Inc

**Description : Sun Horse electronic ballast developed for use with UV & tanning lamp applications**

**This Ballast Will Operate Following Lamps.**

  
 1 OR 2 X F59T12VHO, F60T12VHO,  
 F71T12VHO, F72T12VHO, F73T12VHO,  
 F74T12VHO, F79T12VHO

### ELECTRICAL DATA (208V APPLICATION)

#### MECHANICAL DATA

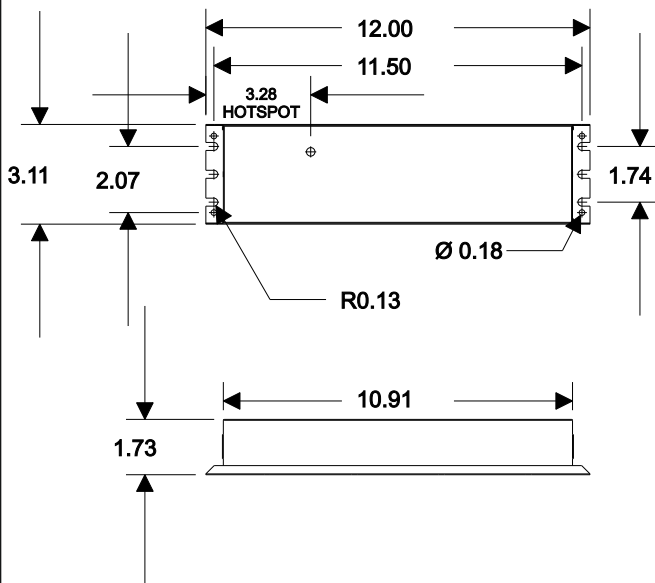

Where : L = Length, W = Width, H = Height

#### WIRING DIAGRAMS

WIRE	BLK	WHT	-	BROWN	YELLOW	RED	BLUE	-
LENGTH-INCHES	72.0	72.0	-	120.0	120.0	120.0	120.0	-

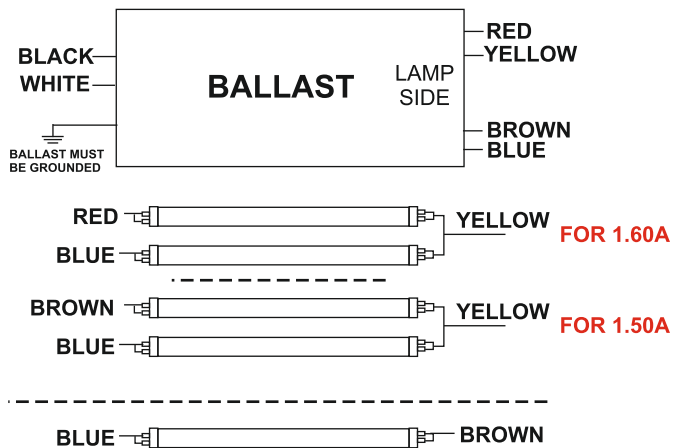

NOTE : This Ballast Case Must Be Grounded

Fulham Co., Inc extends limited warranty only to the original purchaser or to the first user for the period of **3 years** from the date of manufacture as indicated by the date code stamped on each product and when properly installed and under normal conditions of use. For additional warranty guide line, please refer to our Complete Product Catalog OR call Customer Service at 1-323-599-5000.

DUE TO A PROGRAM OF CONTINUOUS IMPROVEMENT, FULHAM Co., INC RESERVES THE RIGHT TO MAKE ANY VARIATION IN DESIGN OR CONSTRUCTION TO THE EQUIPMENT DESCRIBED.

Address : 12705 South Van Ness Ave., Hawthorne, CA 90250 Tel.: 1-323-599-5000, Fax.: 1-323-754-9060. Website: [www.fulham.com](http://www.fulham.com) 2006-223-3 rev C



## SPECIFICATION SHEET : SHGS1-MID-2-200-L-10

This Is An Original Product From Fulham Co., Inc

**Description : Sun Horse electronic ballast developed for use with UV & tanning lamp applications**

**This Ballast Will Operate Following Lamps.**

  
**1 OR 2 X F59T12VHO, F60T12VHO,  
 F71T12VHO, F72T12VHO, F73T12VHO,  
 F74T12VHO, F79T12VHO**

### ELECTRICAL DATA (220V APPLICATION)

INPUT VOLT: 220V ± 10%, 50/60Hz , with 1.60 Amp application								
LAMP WATTS/TYPE	F59T12VHO	F60T12VHO	F71T12VHO	F72T12VHO	F73T12VHO	F74T12VHO	F79T12VHO	F79T12VHO
LAMP RATED POWER	140W	135W	160W	165W	160W	200W	180W	200W
LAMPS OPERATED	1							
INPUT WATTS	129	153	176	195	168	184	172	202
LINE CURRENT:	0.62	0.72	0.82	0.91	0.79	0.86	0.81	0.94
POWER FACTOR	0.95	0.97	0.97	0.98	0.97	0.97	0.97	0.98
BALLAST FACTOR	0.8	0.0	1.0	1.1	1.0	0.9	0.9	0.9
EFFICACY FACTOR	0.6	0.0	0.6	0.6	0.6	0.5	0.5	0.5
OPERATING FREQUENCY	56KHz							
THD	< 20%							
CURRENT CRESS FACTOR	< 1.7							
EMI/RFI COMPLIANCE	FCC PART 18-A							
SOUND RATING	" A "							
BALLAST TYPE	INSTANT START							
VOLTAGE TRANSIENTS	ANSI C82.11 - 1993 / C62.41							
INHERENT THERMAL PROT.	YES							
MIN. OPERATING TEMP	0 °C ( 32 °F )							
MAX. CASE TEMP	75 °C ( 167 °F )							
APPROVALS/CLASS	UL /cUL LISTED, CLASS " P ", 1 OUTDOOR							

### MECHANICAL DATA

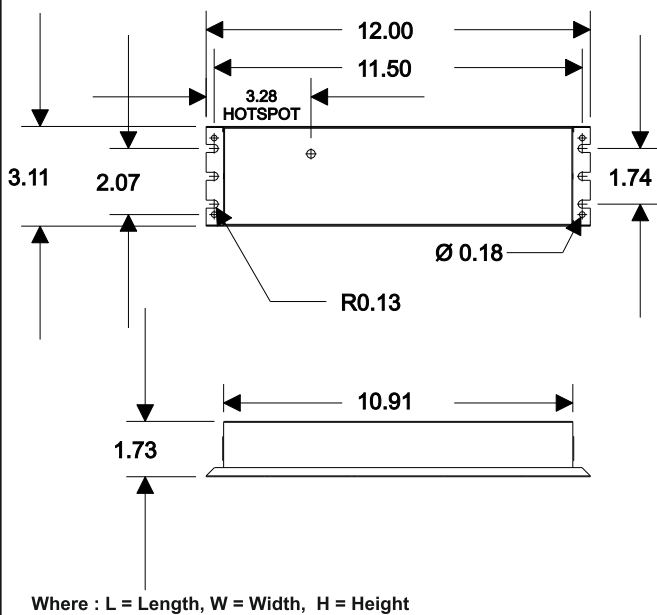

### WIRING DIAGRAMS

WIRE	BLK	WHT	-	BROWN	YELLOW	RED	BLUE	-
LENGTH-INCHES	72.0	72.0	-	120.0	120.0	120.0	120.0	-

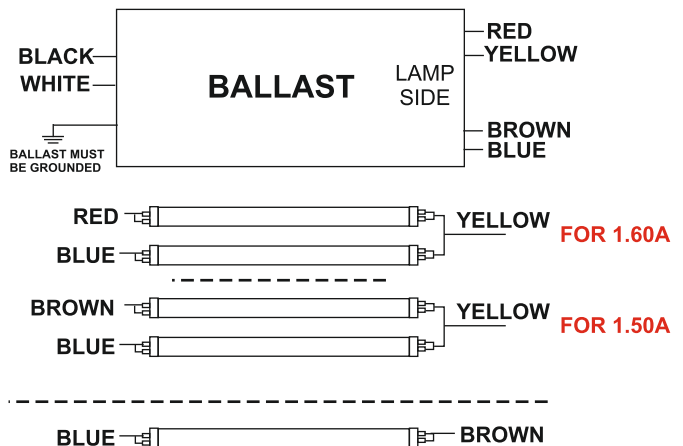

NOTE : This Ballast Case Must Be Grounded

Fulham Co., Inc extends limited warranty only to the original purchaser or to the first user for the period of 3 years from the date of manufacture as indicated by the date code stamped on each product and when properly installed and under normal conditions of use. For additional warranty guide line, please refer to our Complete Product Catalog OR call Customer Service at 1-323-599-5000.

DUE TO A PROGRAM OF CONTINUOUS IMPROVEMENT, FULHAM Co., INC RESERVES THE RIGHT TO MAKE ANY VARIATION IN DESIGN OR CONSTRUCTION TO THE EQUIPMENT DESCRIBED.

Address : 12705 South Van Ness Ave., Hawthorne, CA 90250 Tel.: 1-323-599-5000, Fax.: 1-323-754-9060. Website: www.fulham.com 2006-223-4 rev C



## SPECIFICATION SHEET : SHGS1-MID-2-200-L-10

This Is An Original Product From Fulham Co., Inc

**Description : Sun Horse electronic ballast developed for use with UV & tanning lamp applications**

**This Ballast Will Operate Following Lamps.**

  
**1 OR 2 X F59T12VHO, F60T12VHO,  
 F71T12VHO, F72T12VHO, F73T12VHO,  
 F74T12VHO, F79T12VHO**

### ELECTRICAL DATA (220V APPLICATION)

INPUT VOLT: 220V ± 10%, 50/60Hz, <b>with 1.60 Amp application</b>								
LAMP WATTS/TYPE	F59T12VHO	F60T12VHO	F71T12VHO	F72T12VHO	F73T12VHO	F74T12VHO	F79T12VHO	F79T12VHO
LAMP RATED POWER	140W	135W	160W	165W	160W	200W	180W	200W
LAMPS OPERATED	2							
INPUT WATTS	268	301	313	329	328	351	361	381
LINE CURRENT:	1.23	1.38	1.43	1.51	1.50	1.61	1.65	1.74
POWER FACTOR	0.99	0.99	0.99	0.99	0.99	0.99	0.99	0.99
BALLAST FACTOR	0.9	1.1	0.9	0.9	1.0	0.8	0.9	0.9
EFFICACY FACTOR	0.3	0.4	0.3	0.3	0.3	0.2	0.3	0.2
OPERATING FREQUENCY	56KHz							
THD	< 10%							
CURRENT CRESS FACTOR	< 1.7							
EMI/RFI COMPLIANCE	FCC PART 18-A							
SOUND RATING	"A"							
BALLAST TYPE	INSTANT START							
VOLTAGE TRANSIENTS	ANSI C82.11 - 1993 / C62.41							
INHERENT THERMAL PROT.	YES							
MIN. OPERATING TEMP	0 °C ( 32 °F )							
MAX. CASE TEMP	75 °C ( 167 °F )							
APPROVALS/CLASS	UL /cUL LISTED, CLASS " P ", 1 OUTDOOR							

### MECHANICAL DATA

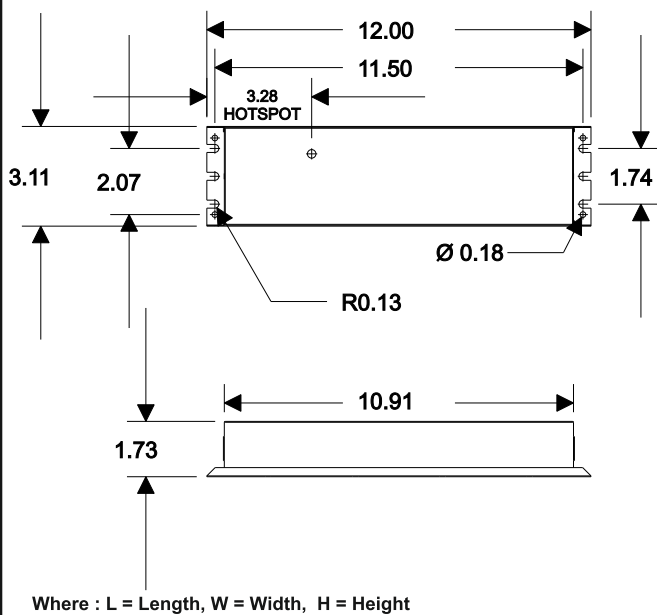

### WIRING DIAGRAMS

WIRE	BLK	WHT	-	BROWN	YELLOW	RED	BLUE	-
LENGTH-INCHES	72.0	72.0	-	120.0	120.0	120.0	120.0	-

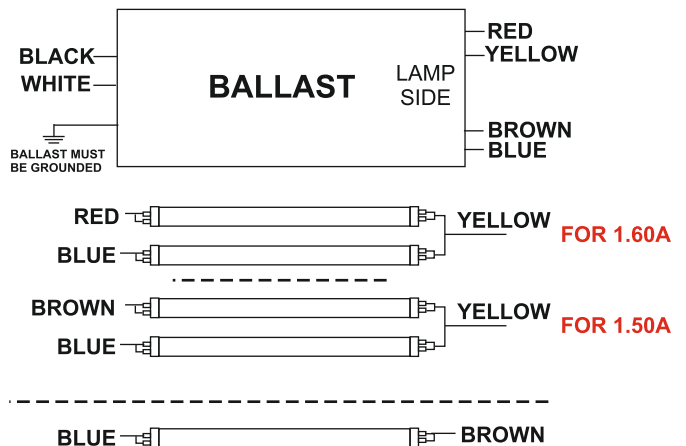

**NOTE : This Ballast Case Must Be Grounded**

Fulham Co., Inc extends limited warranty only to the original purchaser or to the first user for the period of **3 years** from the date of manufacture as indicated by the date code stamped on each product and when properly installed and under normal conditions of use. For additional warranty guide line, please refer to our Complete Product Catalog OR call Customer Service at 1-323-599-5000.

DUE TO A PROGRAM OF CONTINUOUS IMPROVEMENT, FULHAM Co., INC RESERVES THE RIGHT TO MAKE ANY VARIATION IN DESIGN OR CONSTRUCTION TO THE EQUIPMENT DESCRIBED.

Address : 12705 South Van Ness Ave., Hawthorne, CA 90250 Tel.: 1-323-599-5000, Fax.: 1-323-754-9060. Website: [www.fulham.com](http://www.fulham.com) 2006-223-5 rev C



## SPECIFICATION SHEET : SHGS1-MID-2-200-L-10

This Is An Original Product From Fulham Co., Inc

**Description : Sun Horse electronic ballast developed for use with UV & tanning lamp applications**

**This Ballast Will Operate Following Lamps.**

  
 1 OR 2 X F59T12VHO, F60T12VHO,  
 F71T12VHO, F72T12VHO, F73T12VHO,  
 F74T12VHO, F79T12VHO

### ELECTRICAL DATA (220V APPLICATION)

#### MECHANICAL DATA

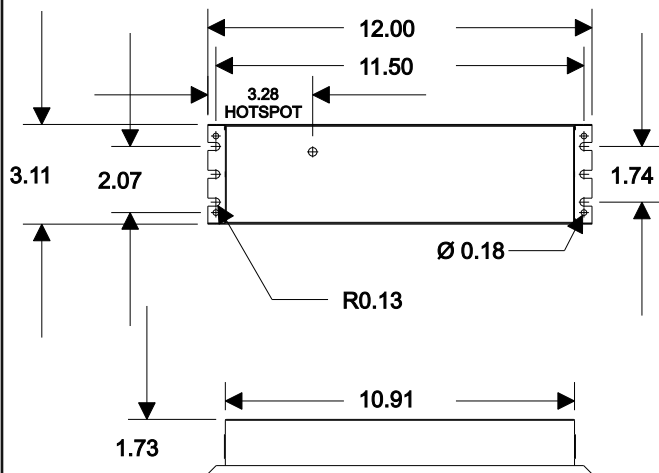

Where : L = Length, W = Width, H = Height

#### WIRING DIAGRAMS

WIRE	BLK	WHT	-	BROWN	YELLOW	RED	BLUE	-
LENGTH-INCHES	72.0	72.0	-	120.0	120.0	120.0	120.0	-

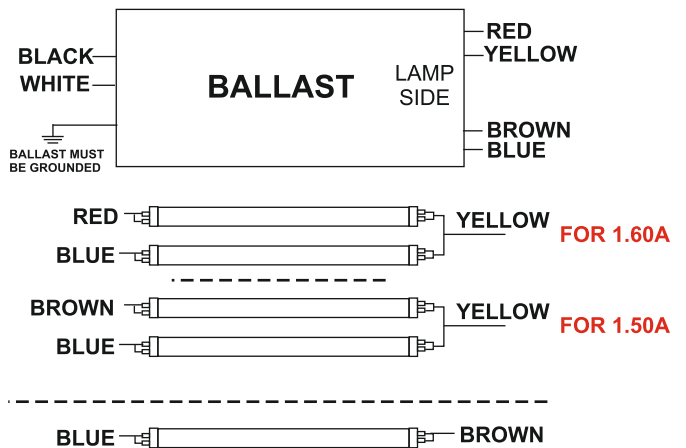

**NOTE : This Ballast Case Must Be Grounded**

Fulham Co., Inc extends limited warranty only to the original purchaser or to the first user for the period of **3 years** from the date of manufacture as indicated by the date code stamped on each product and when properly installed and under normal conditions of use. For additional warranty guide line, please refer to our Complete Product Catalog OR call **Customer Service at 1-323-599-5000**.

DUE TO A PROGRAM OF CONTINUOUS IMPROVEMENT, FULHAM Co., INC RESERVES THE RIGHT TO MAKE ANY VARIATION IN DESIGN OR CONSTRUCTION TO THE EQUIPMENT DESCRIBED.

**Address : 12705 South Van Ness Ave., Hawthorne, CA 90250 Tel.: 1-323-599-5000, Fax.: 1-323-754-9060. Website: [www.fulham.com](http://www.fulham.com) 2006-223-6 rev C**



## SPECIFICATION SHEET : SHGS1-MID-2-200-L-10

This Is An Original Product From Fulham Co., Inc

**Description : Sun Horse electronic ballast developed for use with UV & tanning lamp applications**

**This Ballast Will Operate Following Lamps.**

  
**1 OR 2 X F59T12VHO, F60T12VHO,  
 F71T12VHO, F72T12VHO, F73T12VHO,  
 F74T12VHO, F79T12VHO**

### ELECTRICAL DATA (230V APPLICATION)

INPUT VOLT: 230V ± 10%, 50/60Hz , with 1.60 Amp application								
LAMP WATTS/TYPE	F59T12VHO	F60T12VHO	F71T12VHO	F72T12VHO	F73T12VHO	F74T12VHO	F79T12VHO	F79T12VHO
LAMP RATED POWER	140W	135W	160W	165W	160W	200W	180W	200W
LAMPS OPERATED	1							
INPUT WATTS	129	151	178	190	166	182	171	199
LINE CURRENT:	0.62	0.71	0.82	0.87	0.76	0.83	0.79	0.90
POWER FACTOR	0.91	0.93	0.95	0.95	0.94	0.95	0.95	0.96
BALLAST FACTOR	0.8	1.0	1.0	1.1	1.0	0.8	0.9	0.9
EFFICACY FACTOR	0.6	0.7	0.6	0.6	0.6	0.5	0.5	0.5
OPERATING FREQUENCY	56KHz							
THD	< 20%							
CURRENT CRESS FACTOR	< 1.7							
EMI/RFI COMPLIANCE	FCC PART 18-A							
SOUND RATING	" A "							
BALLAST TYPE	INSTANT START							
VOLTAGE TRANSIENTS	ANSI C82.11 - 1993 / C62.41							
INHERENT THERMAL PROT.	YES							
MIN. OPERATING TEMP	0 °C ( 32 ° F )							
MAX. CASE TEMP	75 °C ( 167 ° F )							
APPROVALS/CLASS	UL /cUL LISTED, CLASS " P ", 1 OUTDOOR							

### MECHANICAL DATA

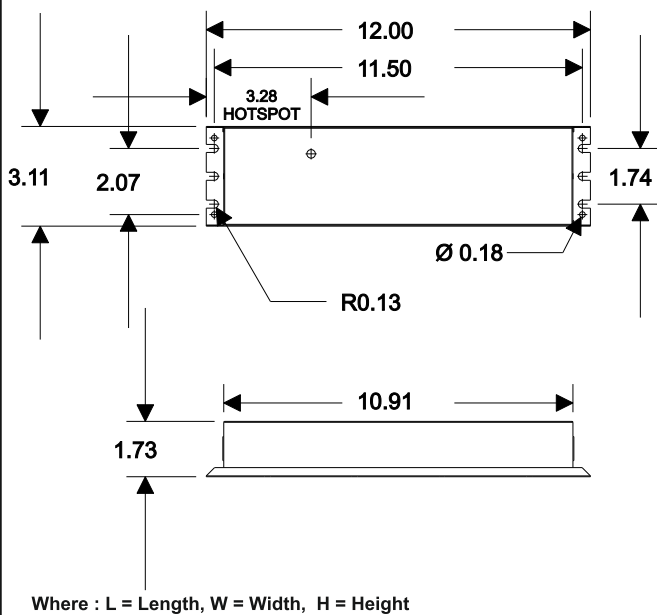

### WIRING DIAGRAMS

WIRE	BLK	WHT	-	BROWN	YELLOW	RED	BLUE	-
LENGTH-INCHES	72.0	72.0	-	120.0	120.0	120.0	120.0	-

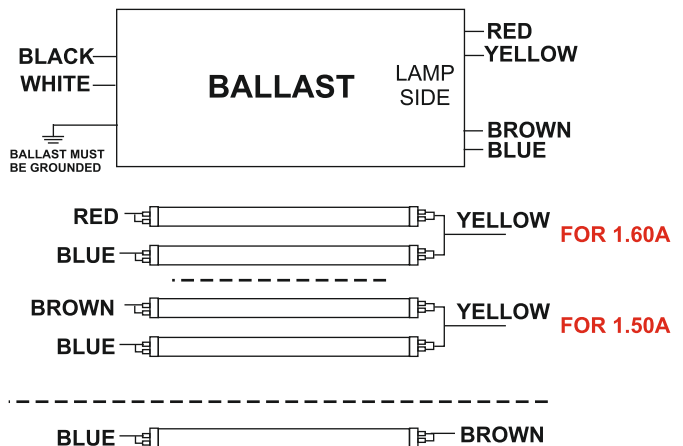

**NOTE : This Ballast Case Must Be Grounded**

Fulham Co., Inc extends limited warranty only to the original purchaser or to the first user for the period of 3 years from the date of manufacture as indicated by the date code stamped on each product and when properly installed and under normal conditions of use. For additional warranty guide line, please refer to our Complete Product Catalog OR call Customer Service at 1-323-599-5000.

DUE TO A PROGRAM OF CONTINUOUS IMPROVEMENT, FULHAM Co., INC RESERVES THE RIGHT TO MAKE ANY VARIATION IN DESIGN OR CONSTRUCTION TO THE EQUIPMENT DESCRIBED.

Address : 12705 South Van Ness Ave., Hawthorne, CA 90250 Tel.: 1-323-599-5000, Fax.: 1-323-754-9060. Website: www.fulham.com 2006-223-7 rev C



## SPECIFICATION SHEET : SHGS1-MID-2-200-L-10

This Is An Original Product From Fulham Co., Inc

**Description : Sun Horse electronic ballast developed for use with  
UV & tanning lamp applications**

**This Ballast Will Operate Following Lamps.**



**1 OR 2 X F59T12VHO, F60T12VHO,  
F71T12VHO, F72T12VHO, F73T12VHO,  
F74T12VHO, F79T12VHO**

### ELECTRICAL DATA (230V APPLICATION)

INPUT VOLT: 230V ± 10%, 50/60Hz, <b>with 1.60 Amp application</b>								
LAMP WATTS/TYPE	F59T12VHO	F60T12VHO	F71T12VHO	F72T12VHO	F73T12VHO	F74T12VHO	F79T12VHO	F79T12VHO
LAMP RATED POWER	140W	135W	160W	165W	160W	200W	180W	200W
LAMPS OPERATED	2							
INPUT WATTS	263	296	310	325	324	351	360	377
LINE CURRENT:	1.17	1.31	1.37	1.43	1.43	1.55	1.58	1.66
POWER FACTOR	0.98	0.98	0.98	0.99	0.99	0.99	0.99	0.99
BALLAST FACTOR	0.9	1.0	0.9	0.9	1.0	0.8	0.9	0.9
EFFICACY FACTOR	0.3	0.4	0.3	0.3	0.3	0.2	0.3	0.2
OPERATING FREQUENCY	56KHz							
THD	< 10%							
CURRENT CRESS FACTOR	< 1.7							
EMI/RFI COMPLIANCE	FCC PART 18-A							
SOUND RATING	" A "							
BALLAST TYPE	INSTANT START							
VOLTAGE TRANSIENTS	ANSI C82.11 - 1993 / C62.41							
INHERENT THERMAL PROT.	YES							
MIN. OPERATING TEMP	0 °C ( 32 °F )							
MAX. CASE TEMP	75 °C ( 167 °F )							
APPROVALS/CLASS	UL /cUL LISTED, CLASS " P ", 1 OUTDOOR							

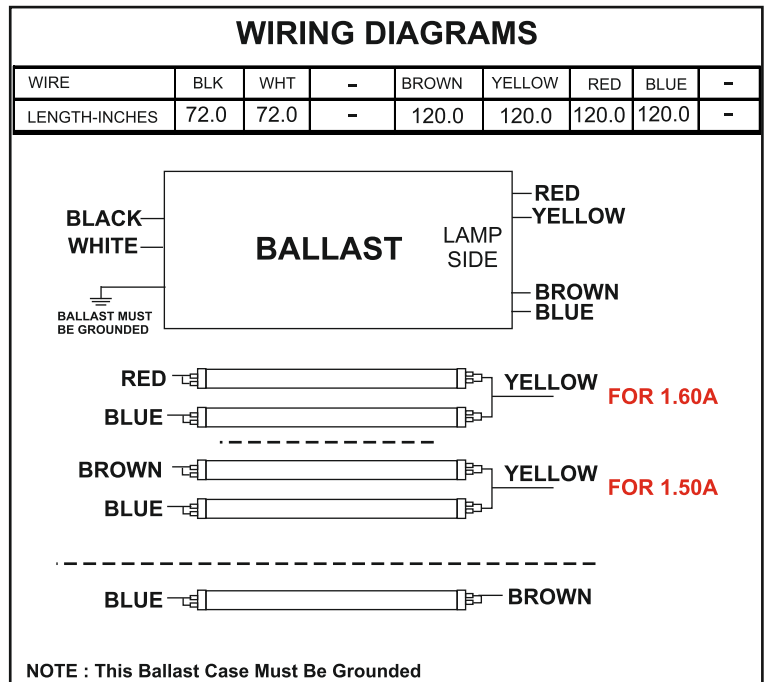
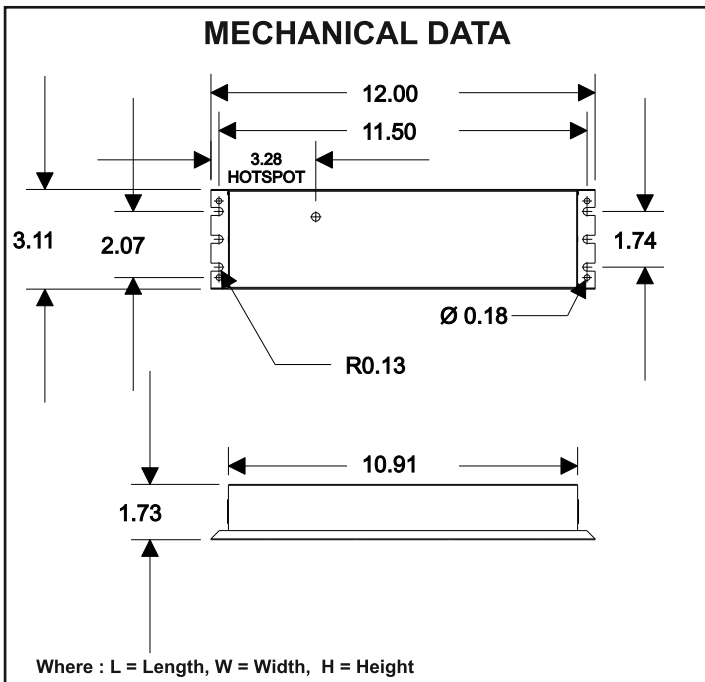

Fulham Co., Inc extends limited warranty only to the original purchaser or to the first user for the period of **3 years** from the date of manufacture as indicated by the date code stamped on each product and when properly installed and under normal conditions of use. For additional warranty guide line, please refer to our Complete Product Catalog OR call Customer Service at 1-323-599-5000.





## SPECIFICATION SHEET : SHGS1-MID-2-200-L-10

This Is An Original Product From Fulham Co., Inc

**Description : Sun Horse electronic ballast developed for use with  
UV & tanning lamp applications**

**This Ballast Will Operate Following Lamps.**

  
 1 OR 2 X F59T12VHO, F60T12VHO,  
 F71T12VHO, F72T12VHO, F73T12VHO,  
 F74T12VHO, F79T12VHO

### ELECTRICAL DATA (230V APPLICATION)

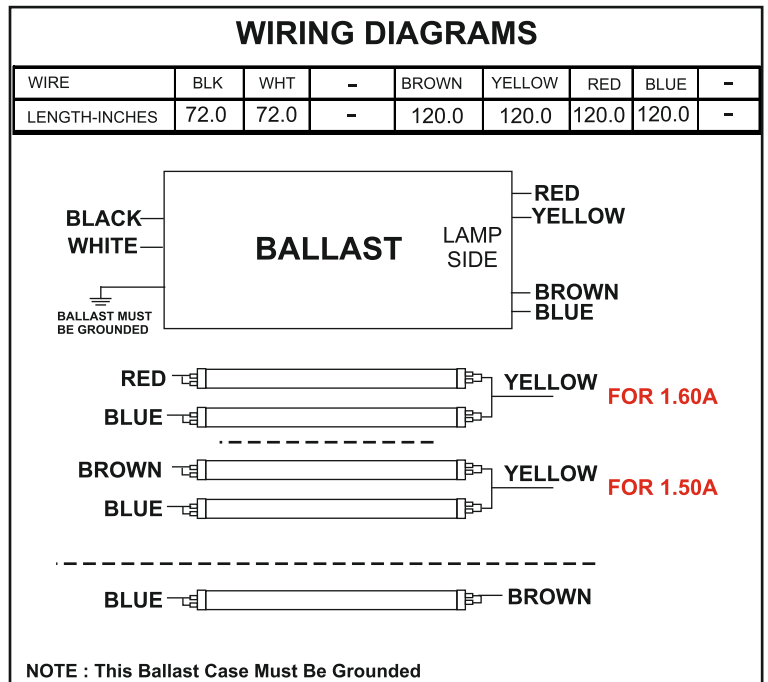
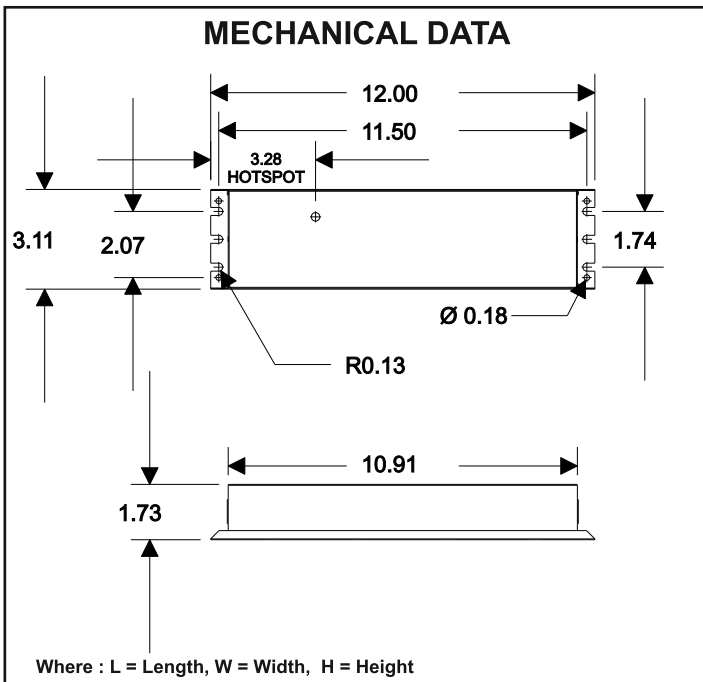

Fulham Co., Inc extends limited warranty only to the original purchaser or to the first user for the period of **3 years** from the date of manufacture as indicated by the date code stamped on each product and when properly installed and under normal conditions of use. For additional warranty guide line, please refer to our Complete Product Catalog OR call Customer Service at 1-323-599-5000.



## SPECIFICATION SHEET : SHGS1-MID-2-200-L-10

This Is An Original Product From Fulham Co., Inc

**Description : Sun Horse electronic ballast developed for use with UV & tanning lamp applications**

**This Ballast Will Operate Following Lamps.**



**1 OR 2 X F59T12VHO, F60T12VHO, F71T12VHO, F72T12VHO, F73T12VHO, F74T12VHO, F79T12VHO**

### ELECTRICAL DATA (240V APPLICATION)

INPUT VOLT: 240V ± 10%, 50/60Hz , with 1.60 Amp application								
LAMP WATTS/TYPE	F59T12VHO	F60T12VHO	F71T12VHO	F72T12VHO	F73T12VHO	F74T12VHO	F79T12VHO	F79T12VHO
LAMP RATED POWER	140W	135W	160W	165W	160W	200W	180W	200W
LAMPS OPERATED	1							
INPUT WATTS	129	151	178	190	166	182	171	199
LINE CURRENT:	0.59	0.67	0.78	0.82	0.73	0.80	0.75	0.86
POWER FACTOR	0.91	0.93	0.95	0.95	0.94	0.95	0.95	0.96
BALLAST FACTOR	0.8	1.0	1.0	1.1	1.0	0.8	0.9	0.9
EFFICACY FACTOR	0.6	0.7	0.6	0.6	0.6	0.5	0.5	0.5
OPERATING FREQUENCY	56KHz							
THD	< 20%							
CURRENT CRESS FACTOR	< 1.7							
EMI/RFI COMPLIANCE	FCC PART 18-A							
SOUND RATING	" A "							
BALLAST TYPE	INSTANT START							
VOLTAGE TRANSIENTS	ANSI C82.11 - 1993 / C62.41							
INHERENT THERMAL PROT.	YES							
MIN. OPERATING TEMP	0 °C ( 32 °F )							
MAX. CASE TEMP	75 °C ( 167 °F )							
APPROVALS/CLASS	UL /cUL LISTED, CLASS " P ", 1 OUTDOOR							

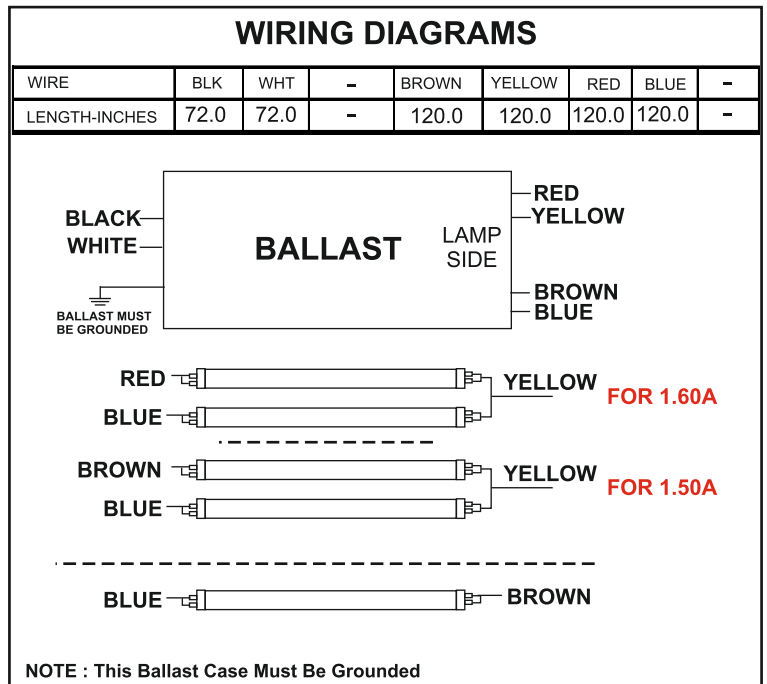
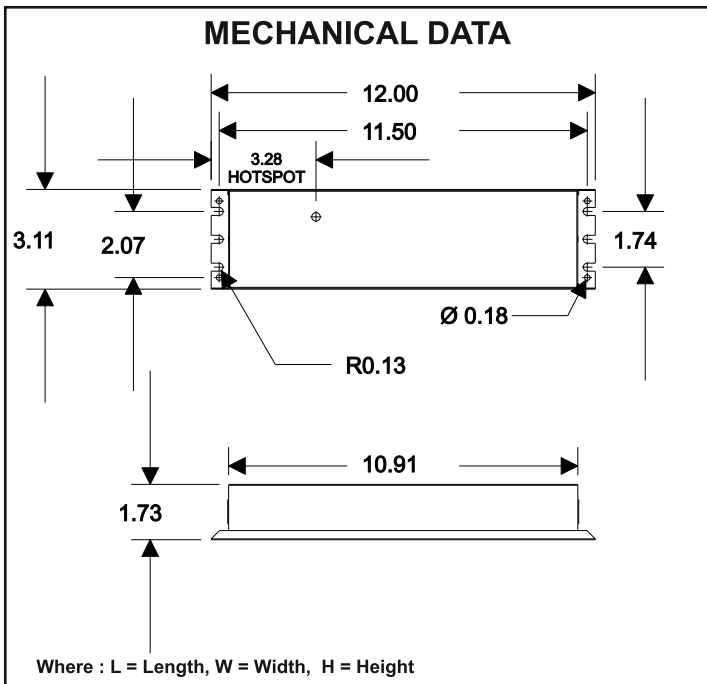

Fulham Co., Inc extends limited warranty only to the original purchaser or to the first user for the period of 3 years from the date of manufacture as indicated by the date code stamped on each product and when properly installed and under normal conditions of use. For additional warranty guide line, please refer to our Complete Product Catalog OR call Customer Service at 1-323-599-5000.



## SPECIFICATION SHEET : SHGS1-MID-2-200-L-10

This Is An Original Product From Fulham Co., Inc

**Description : Sun Horse electronic ballast developed for use with UV & tanning lamp applications**

**This Ballast Will Operate Following Lamps.**



**1 OR 2 X F59T12VHO, F60T12VHO, F71T12VHO, F72T12VHO, F73T12VHO, F74T12VHO, F79T12VHO**

### ELECTRICAL DATA (240V APPLICATION)

INPUT VOLT: 240V ± 10%, 50/60Hz, with 1.60 Amp application								
LAMP WATTS/TYPE	F59T12VHO	F60T12VHO	F71T12VHO	F72T12VHO	F73T12VHO	F74T12VHO	F79T12VHO	F79T12VHO
LAMP RATED POWER	140W	135W	160W	165W	160W	200W	180W	200W
LAMPS OPERATED	2							
INPUT WATTS	263	296	310	325	324	351	360	377
LINE CURRENT:	1.12	1.25	1.31	1.37	1.37	1.47	1.52	1.59
POWER FACTOR	0.98	0.98	0.98	0.99	0.99	0.99	0.99	0.99
BALLAST FACTOR	0.9	1.0	0.9	0.9	1.0	0.8	0.9	0.9
EFFICACY FACTOR	0.3	0.4	0.3	0.3	0.3	0.2	0.3	0.2
OPERATING FREQUENCY	56KHz							
THD	< 10%							
CURRENT CRESS FACTOR	< 1.7							
EMI/RFI COMPLIANCE	FCC PART 18-A							
SOUND RATING	" A "							
BALLAST TYPE	INSTANT START							
VOLTAGE TRANSIENTS	ANSI C82.11 - 1993 / C62.41							
INHERENT THERMAL PROT.	YES							
MIN. OPERATING TEMP	0 °C ( 32 ° F )							
MAX. CASE TEMP	75 °C ( 167 ° F )							
APPROVALS/CLASS	UL /cUL LISTED, CLASS " P ", 1 OUTDOOR							

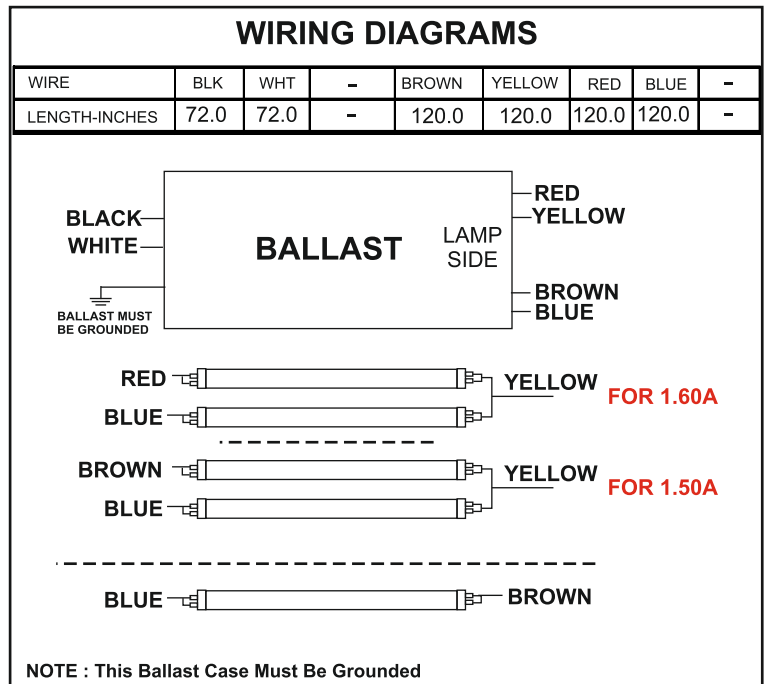
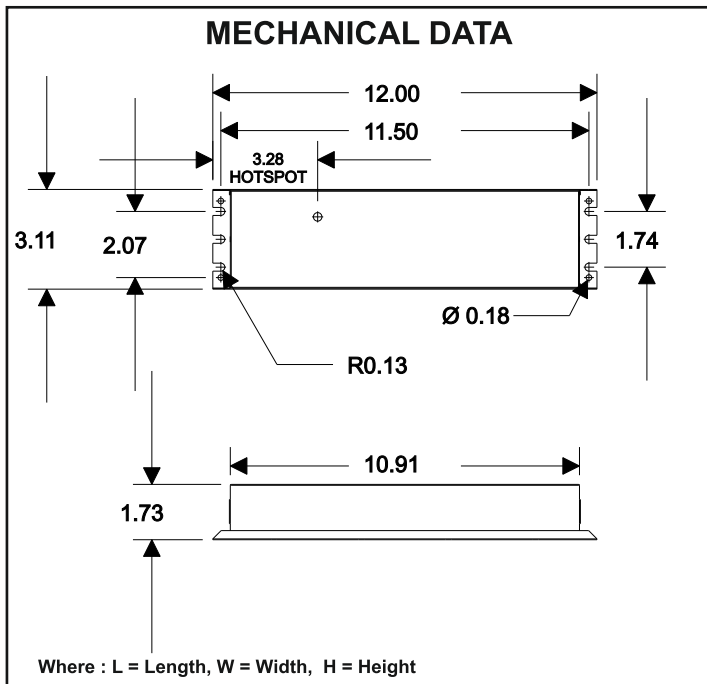

Fulham Co., Inc extends limited warranty only to the original purchaser or to the first user for the period of **3 years** from the date of manufacture as indicated by the date code stamped on each product and when properly installed and under normal conditions of use. For additional warranty guide line, please refer to our Complete Product Catalog OR call Customer Service at 1-323-599-5000.



## SPECIFICATION SHEET : SHGS1-MID-2-200-L-10

This Is An Original Product From Fulham Co., Inc

**Description : Sun Horse electronic ballast developed for use with UV & tanning lamp applications**

**This Ballast Will Operate Following Lamps.**



1 OR 2 X F59T12VHO, F60T12VHO,  
F71T12VHO, F72T12VHO, F73T12VHO,  
F74T12VHO, F79T12VHO

### ELECTRICAL DATA (240V APPLICATION)

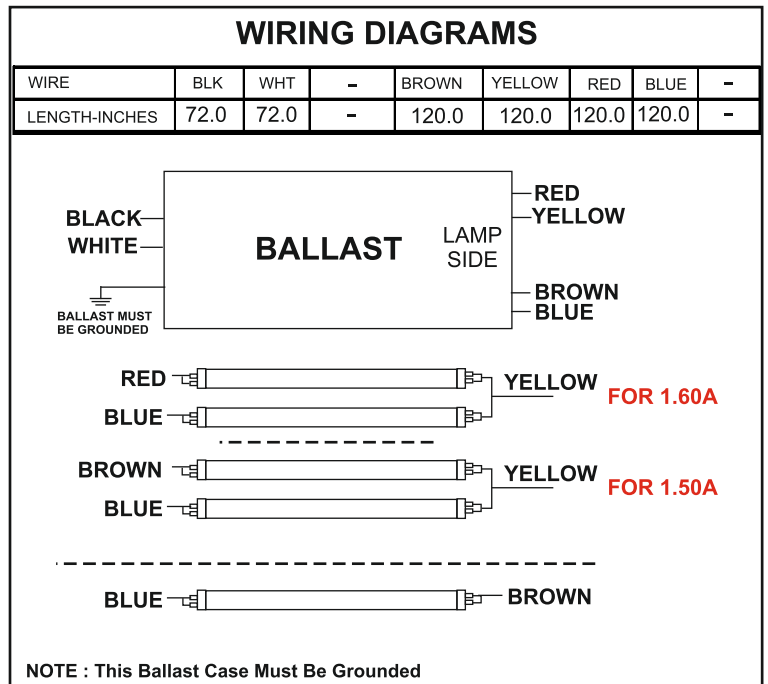
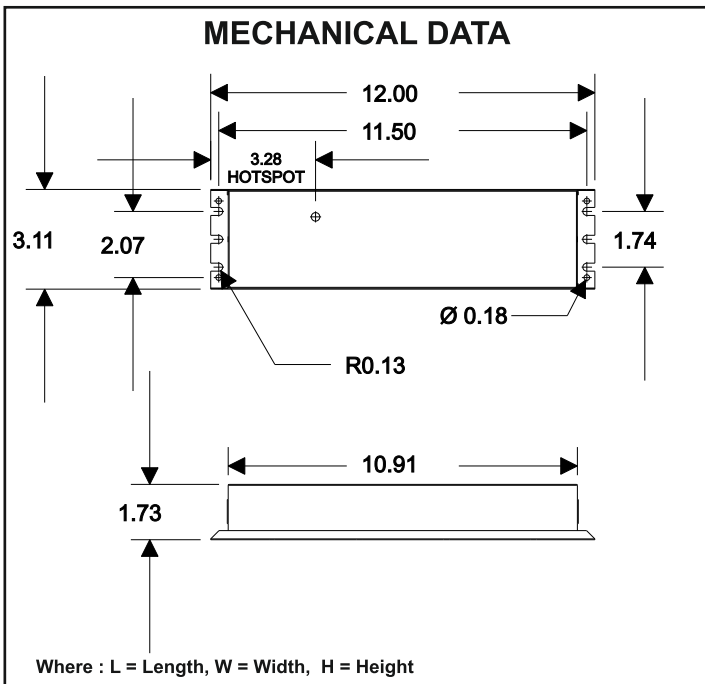

Fulham Co., Inc extends limited warranty only to the original purchaser or to the first user for the period of **3 years** from the date of manufacture as indicated by the date code stamped on each product and when properly installed and under normal conditions of use. For additional warranty guide line, please refer to our Complete Product Catalog OR call Customer Service at 1-323-599-5000.